

VERVORMER

|| voor monokorden
|| & monofone generatoren

Loopos newormer

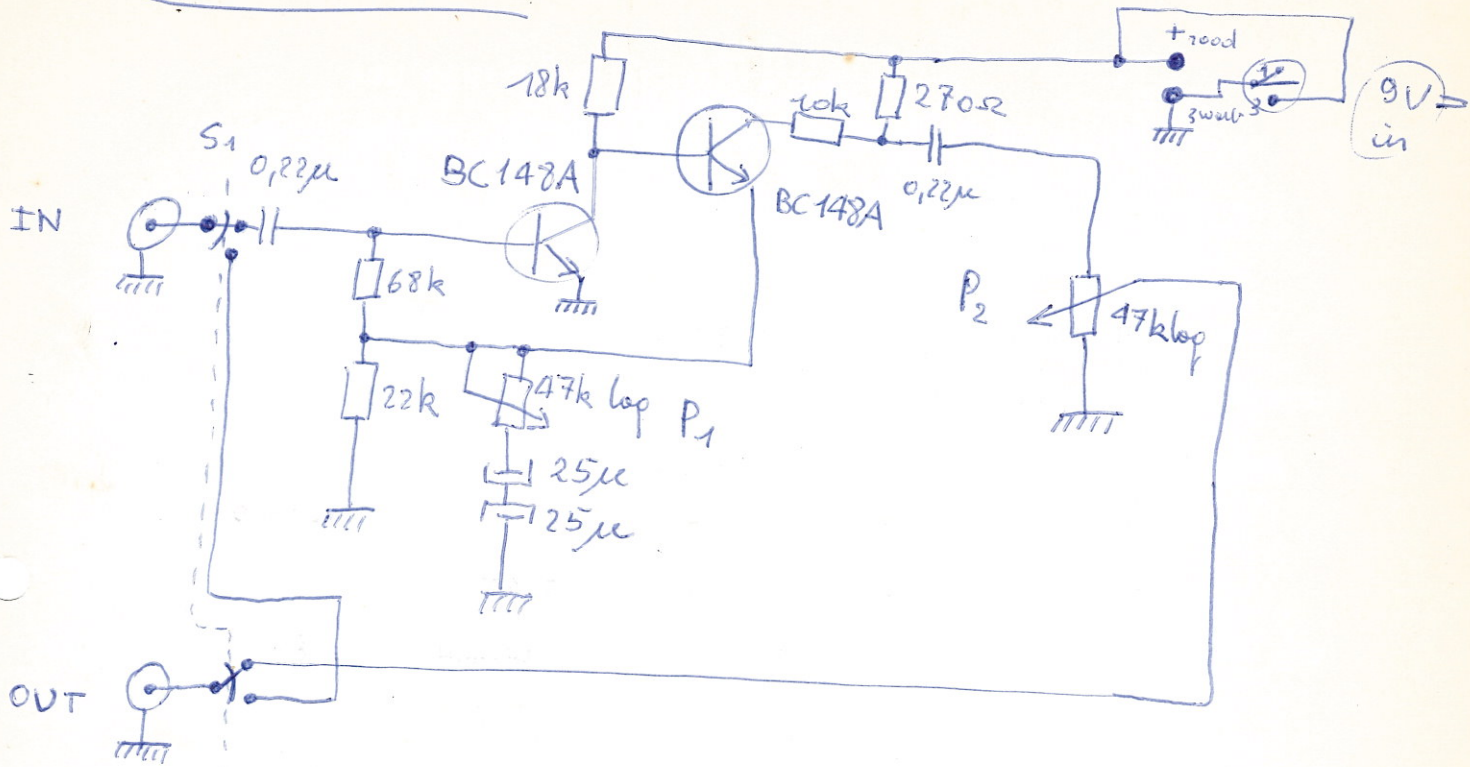

- neworming (regelbaar op P₁)
 - extra versterking lage tonen
-

lay out

voorz

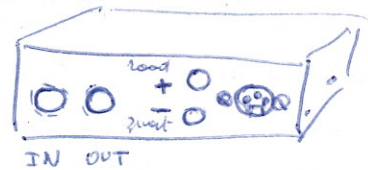
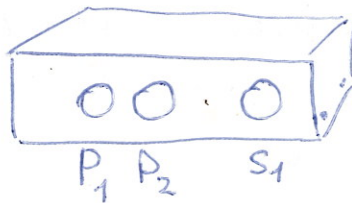

achter

(φ6,3)

komponenten opstelling op miniprint

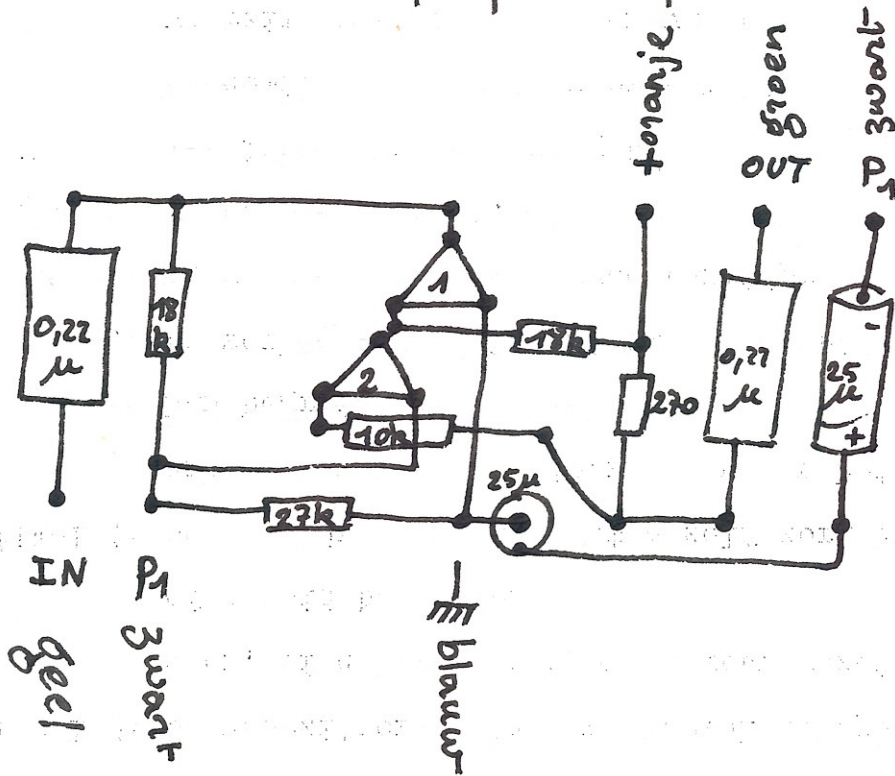

9V D.C. aansluiting: DIN 3p.

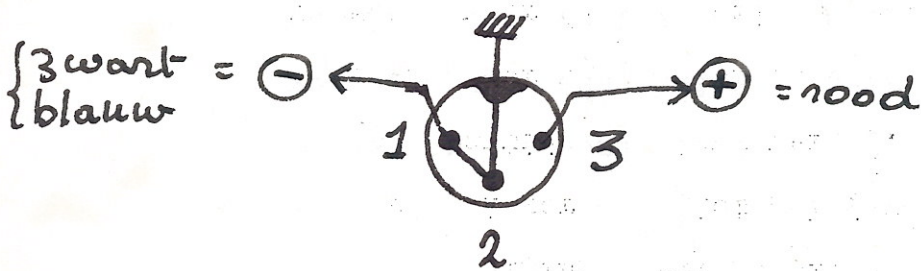

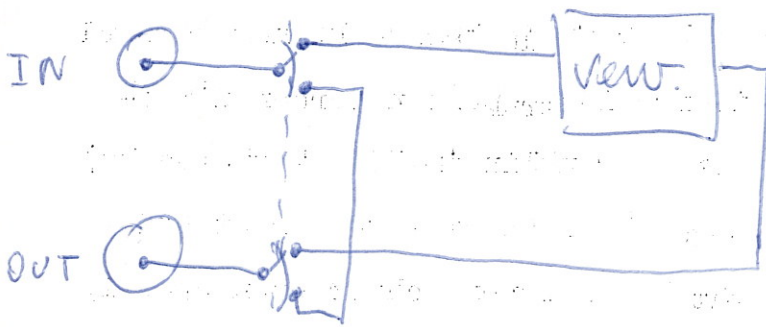

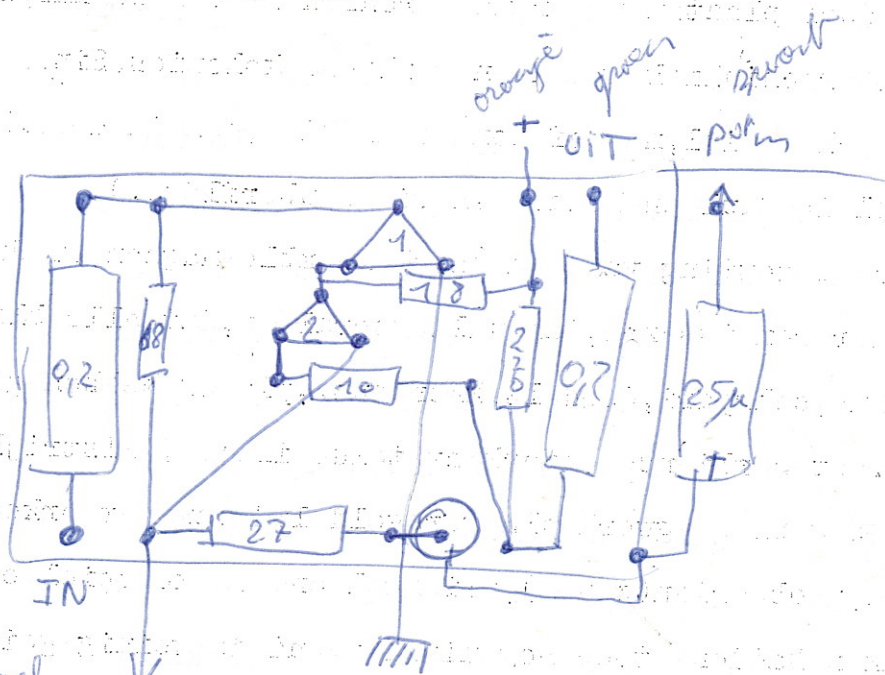

IN
 gel
 Pöbm.
 vast
 zwart

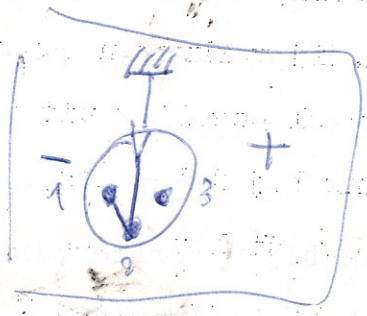

rood = +
 zwart = - x mema

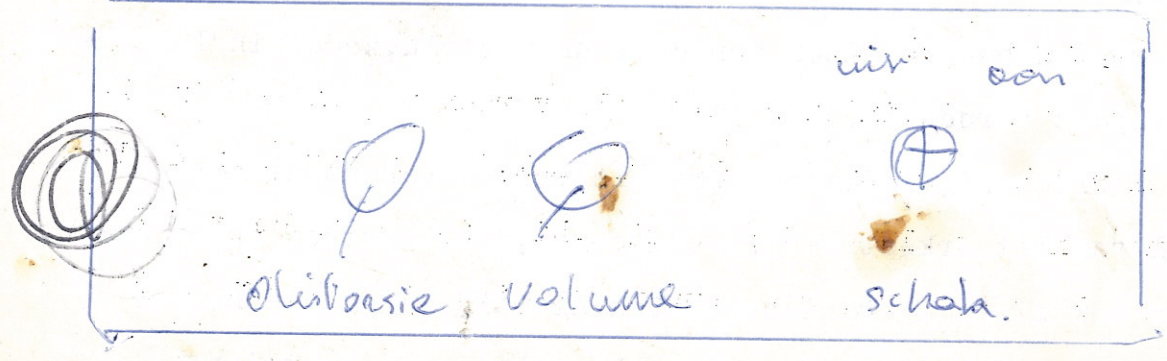

Verwarming monokord

BC 148 A (TUN)

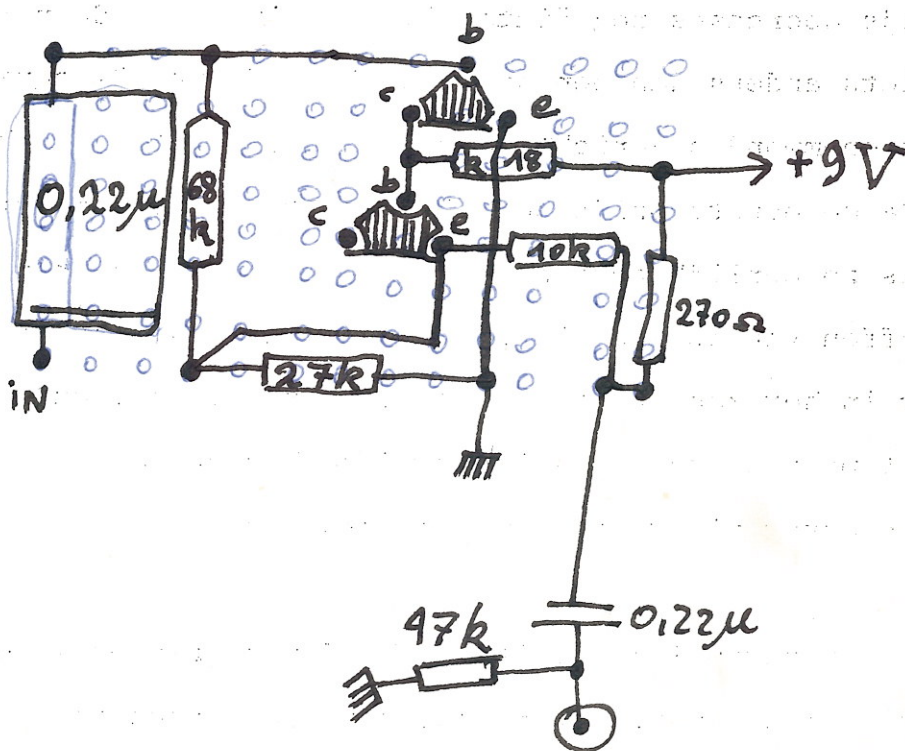
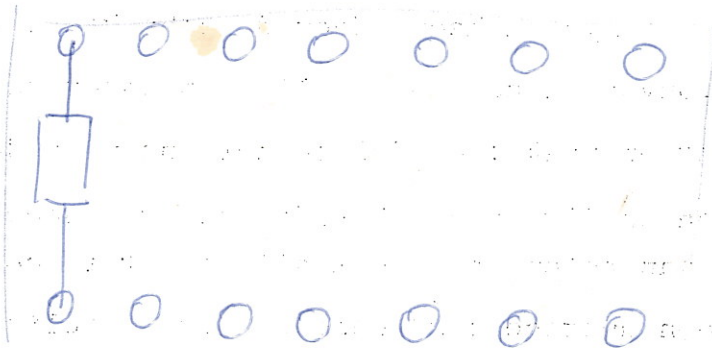
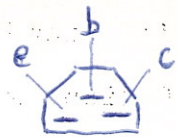

komponentenlijst a kostprijsrekening

BC 148 A	2	14,-	28,-
BC 148 A	"	"	"
MK4 kastje	1	42,-	42,-
5 weerstanden	5	1,-	5,-
2 0,22μ	2	6,-	12,-
1 schak.	1	22,-	22,-
2 potm.	2	16,-	32,-
1 DIN ♀	1	10,-	10,-
2 bonussen ♀	2	2,5,-	5,-
2 jock ♀ 63	2	10,-	20,-
2 25μF	2	6,-	12,-
1 print	1	20,-	20,-
4 m draad	4	1,5,-	6,-
2 m solder	2	5,-	10,-
3 knoppe	3	7,-	21,-

245,-