

STICHTING LOGOS  
instelling van openbaar nut  
Kongostraat 35  
B-9000 Gent  
tel. 091-23.80.89

# Manipulofoon

06/82

voor: "Time frames"

STICHTING LOGOS - atelier voor alternatieve instrumentenbouw

**24V-dc**

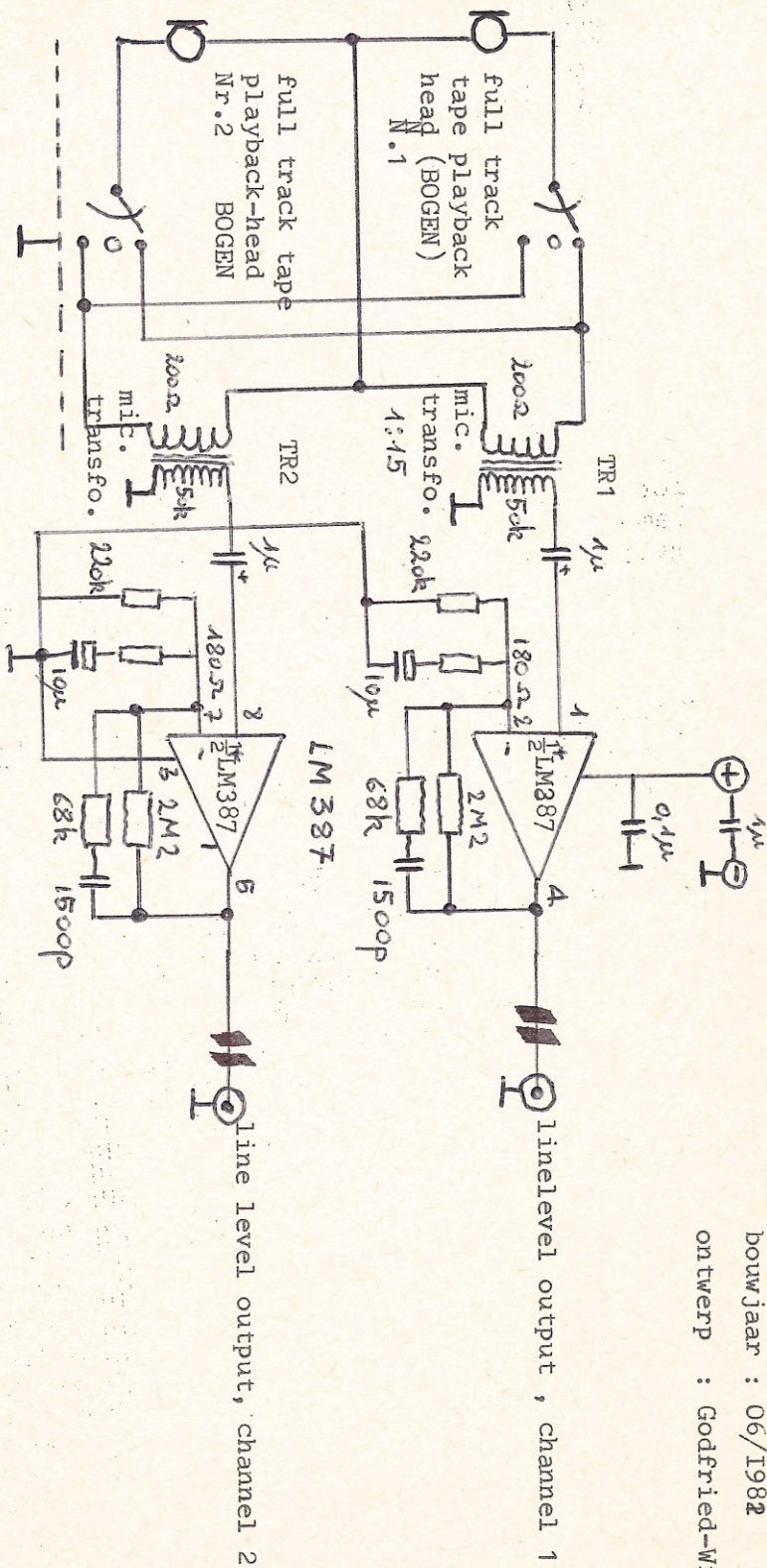

" M A N I P U L O F O O N "

=====  
bouwjaar : 06/1982

ontwerp : Godfried-Willem RAES.

$$= \frac{10^6}{11304} = 88 H_3$$

$$f_0 = \frac{1}{2\pi C_2 R_6} = \frac{1}{6.28 \cdot 10^{-6} \cdot 180}$$

$$= \frac{10^6}{20724} = 48 H_3$$

$$f_1 = \frac{1}{2\pi C_4 R_4} = \frac{1}{6.28 \cdot 1500 \cdot 10^{-12} \cdot 2.2 \cdot 10^6}$$

$$= \frac{10^9}{640560} = \boxed{1561 H_3}$$

$$f_2 = \frac{1}{2\pi C_4 R_7} = \frac{1}{6.28 \cdot 1500 \cdot 10^{-12} \cdot 68 \cdot 10^3}$$

$$= 378.7 \times$$

Gain below  $f_2$   $OB_{mid} = \frac{R_7 + R_6}{R_6} = \frac{68k + 180\Omega}{180\Omega}$

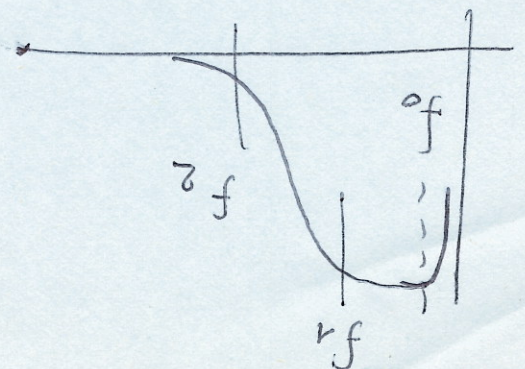

MANIPULOFON

# Manipulation

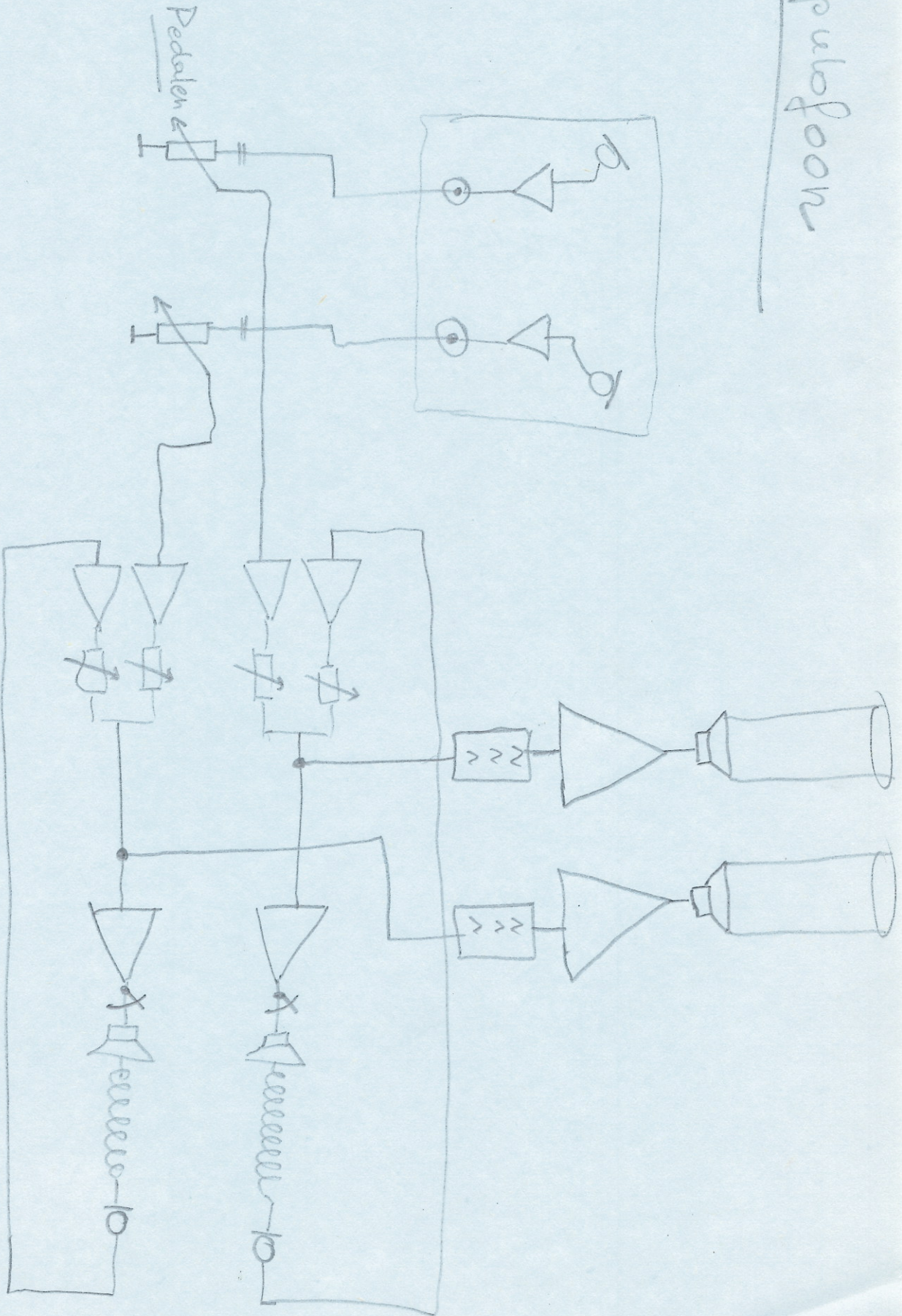

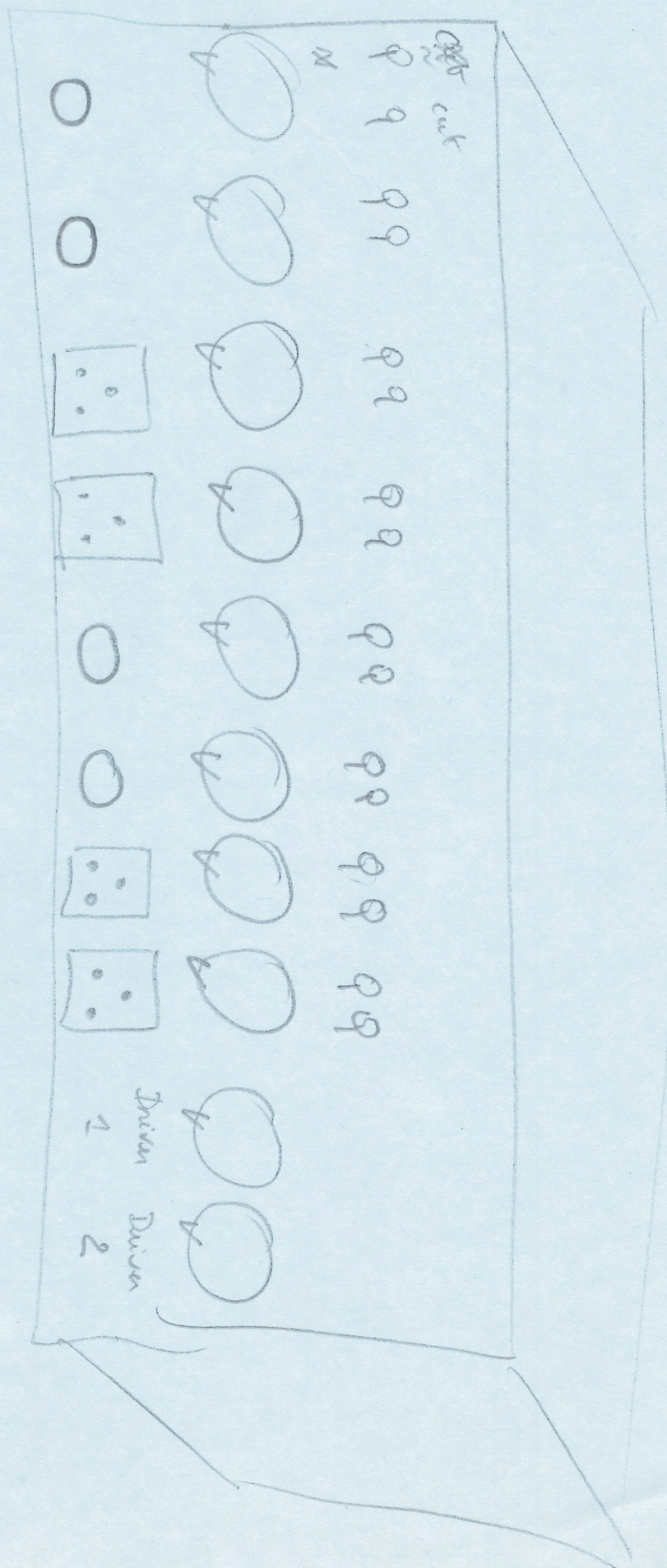

CH 1 only:

Mixer

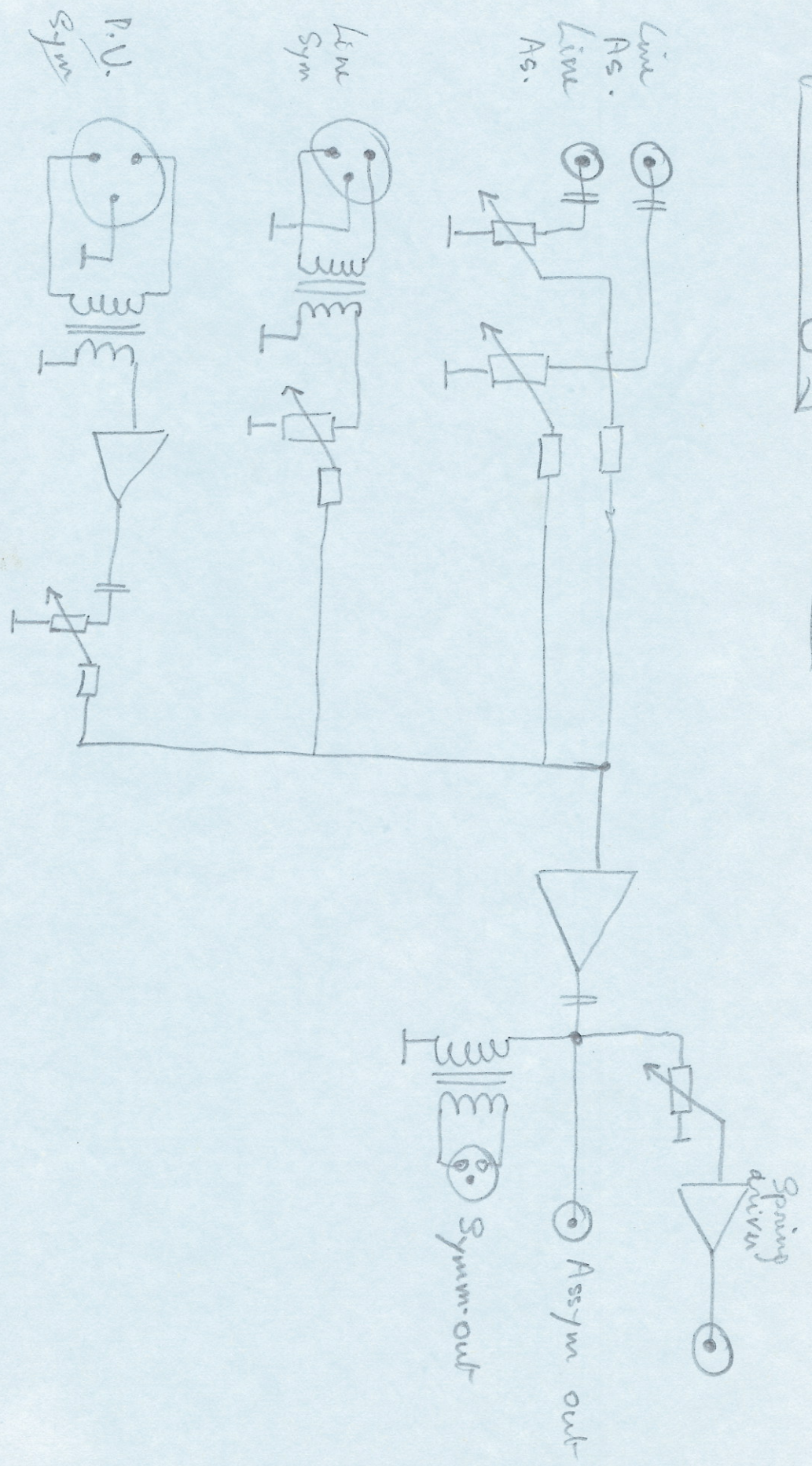

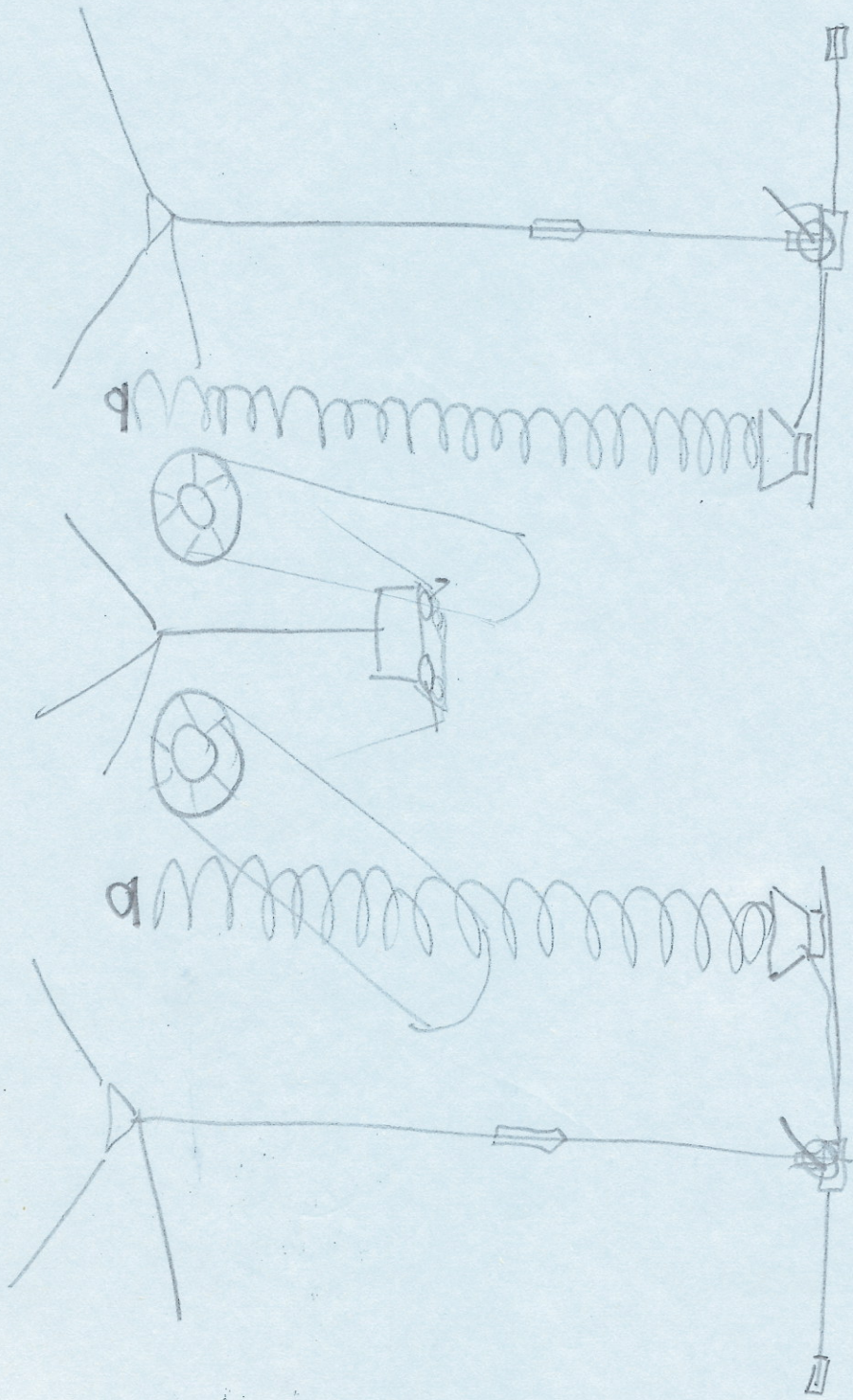

boven - ZICHT

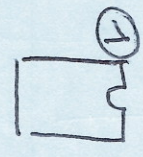

BANDER - ZICHT

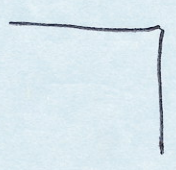
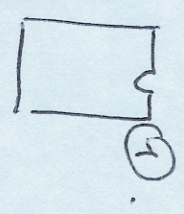
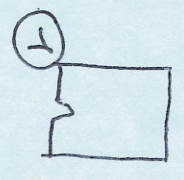



5-9.

2-19.

TL072

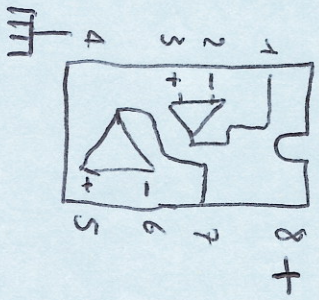

CM 387

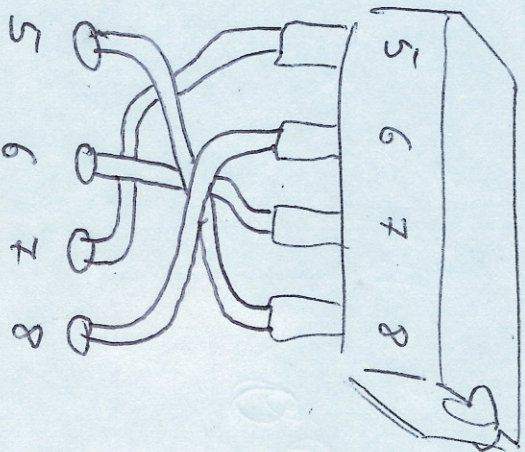
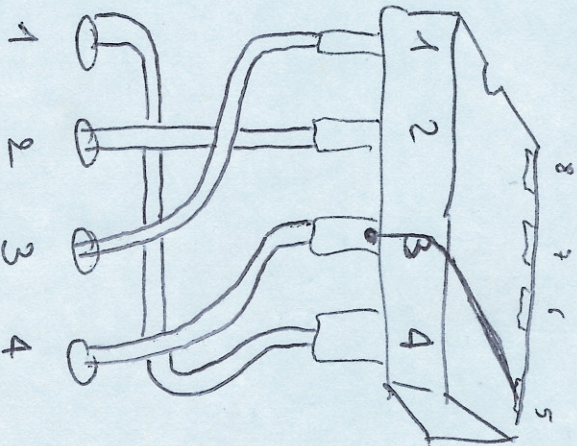
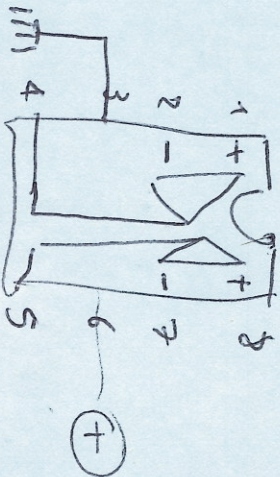

200 : 10k  
 1 : 7  
 1V : 7V

10k / 200

LF 356 Feb  
 357

Sic 2x

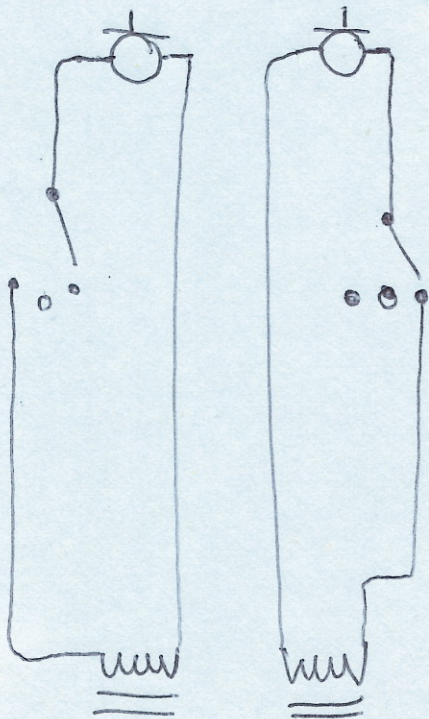
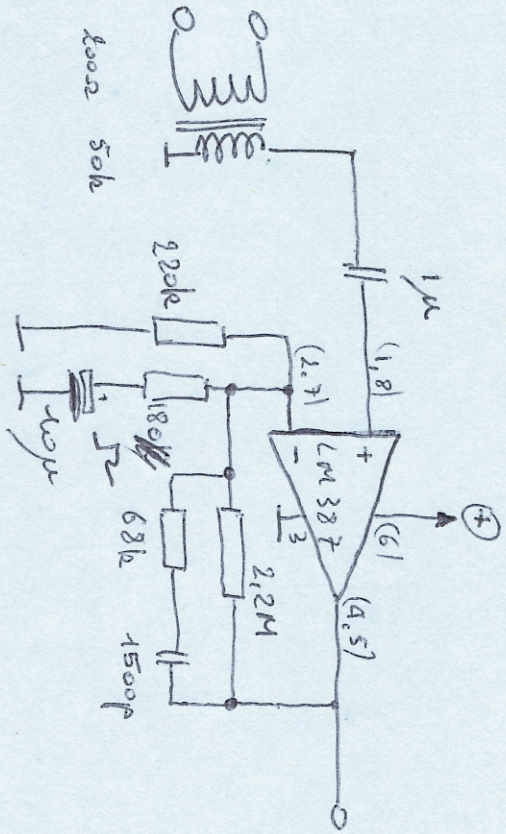

*[Handwritten scribble]*

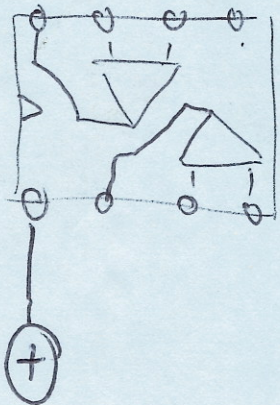
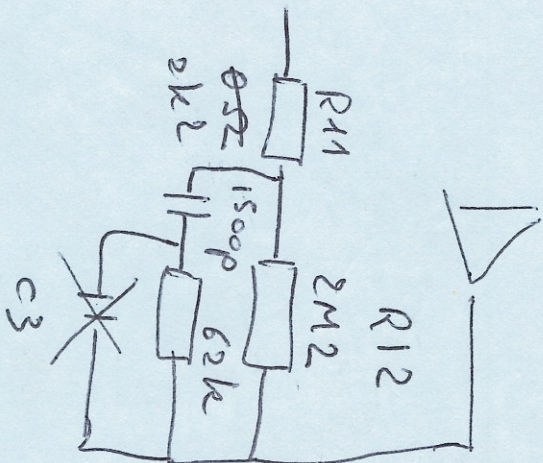
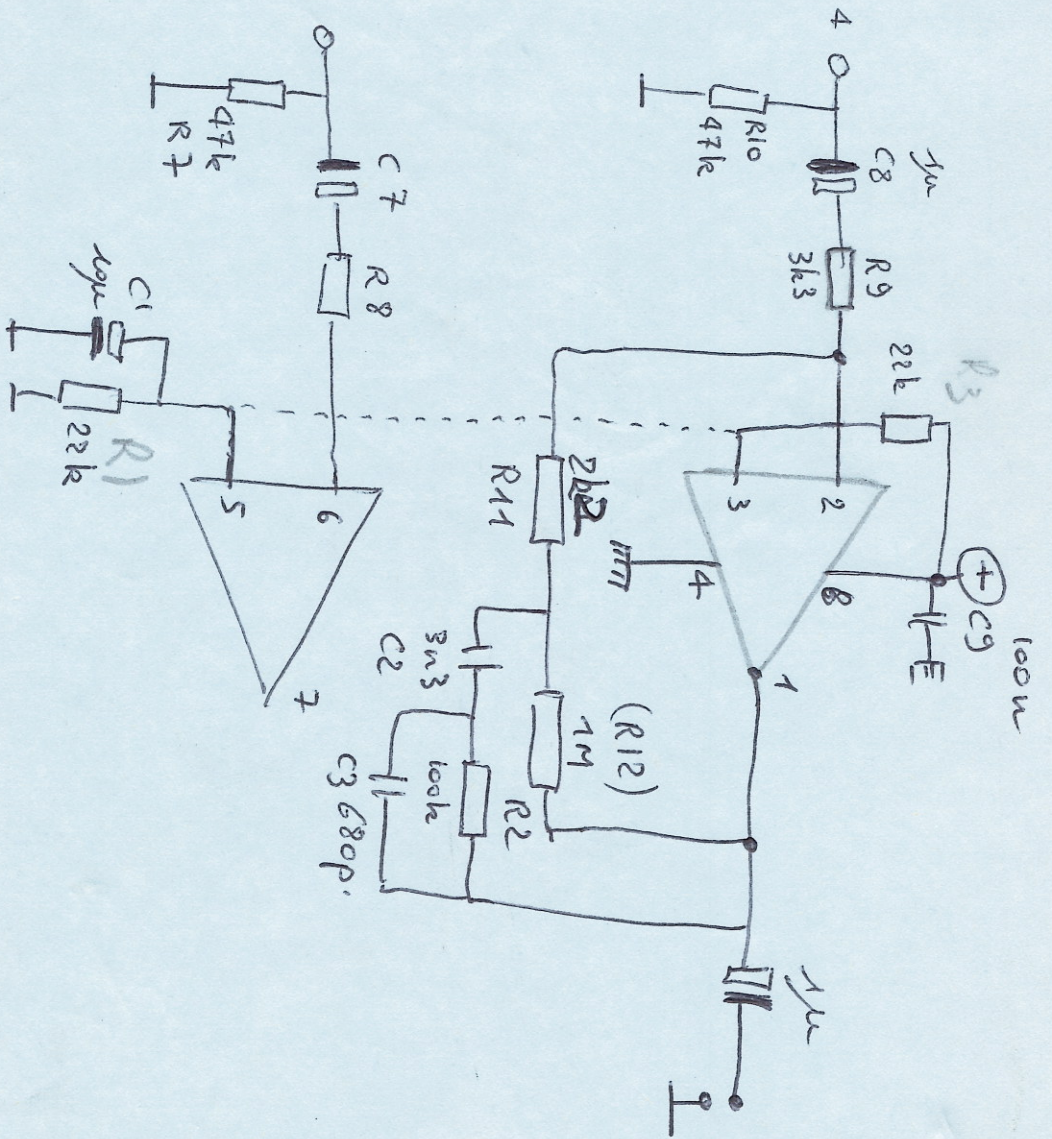

V.L

5

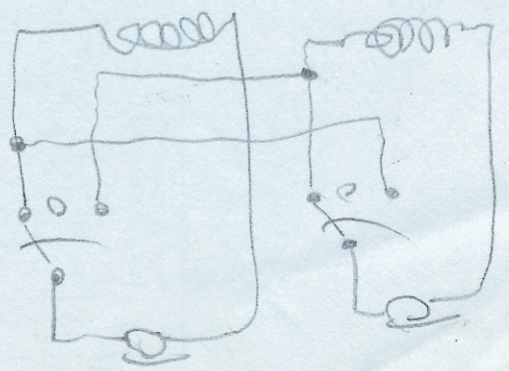
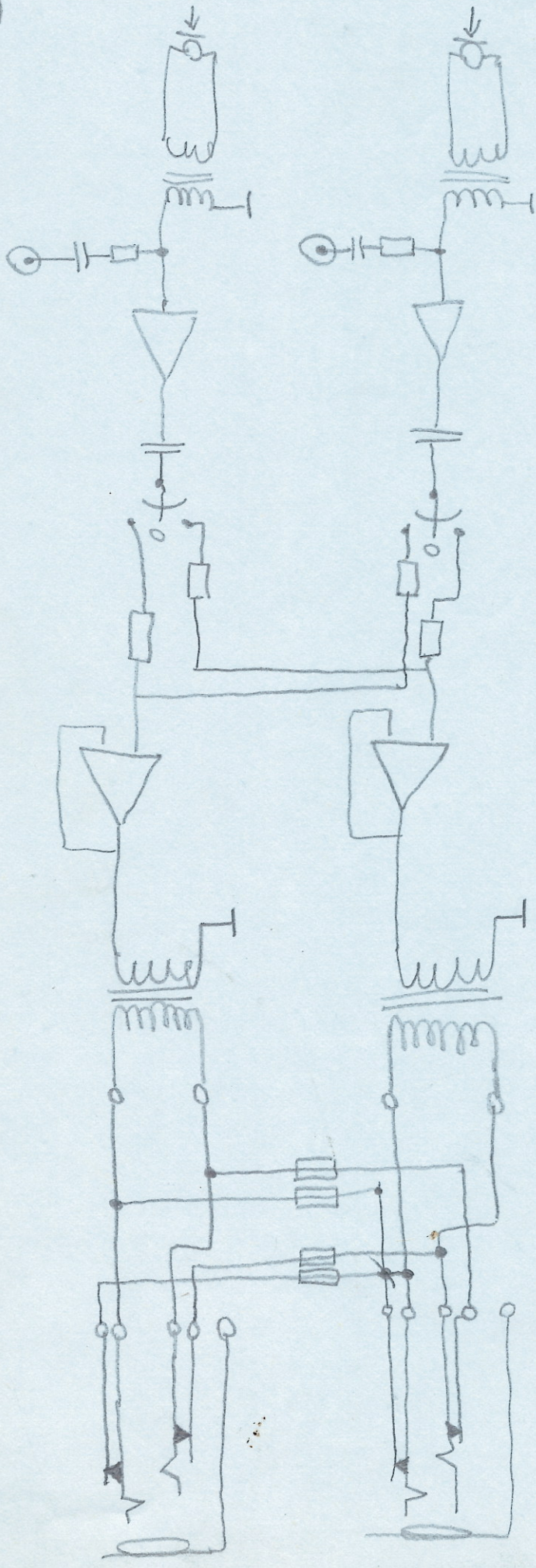

LM 317  
05.

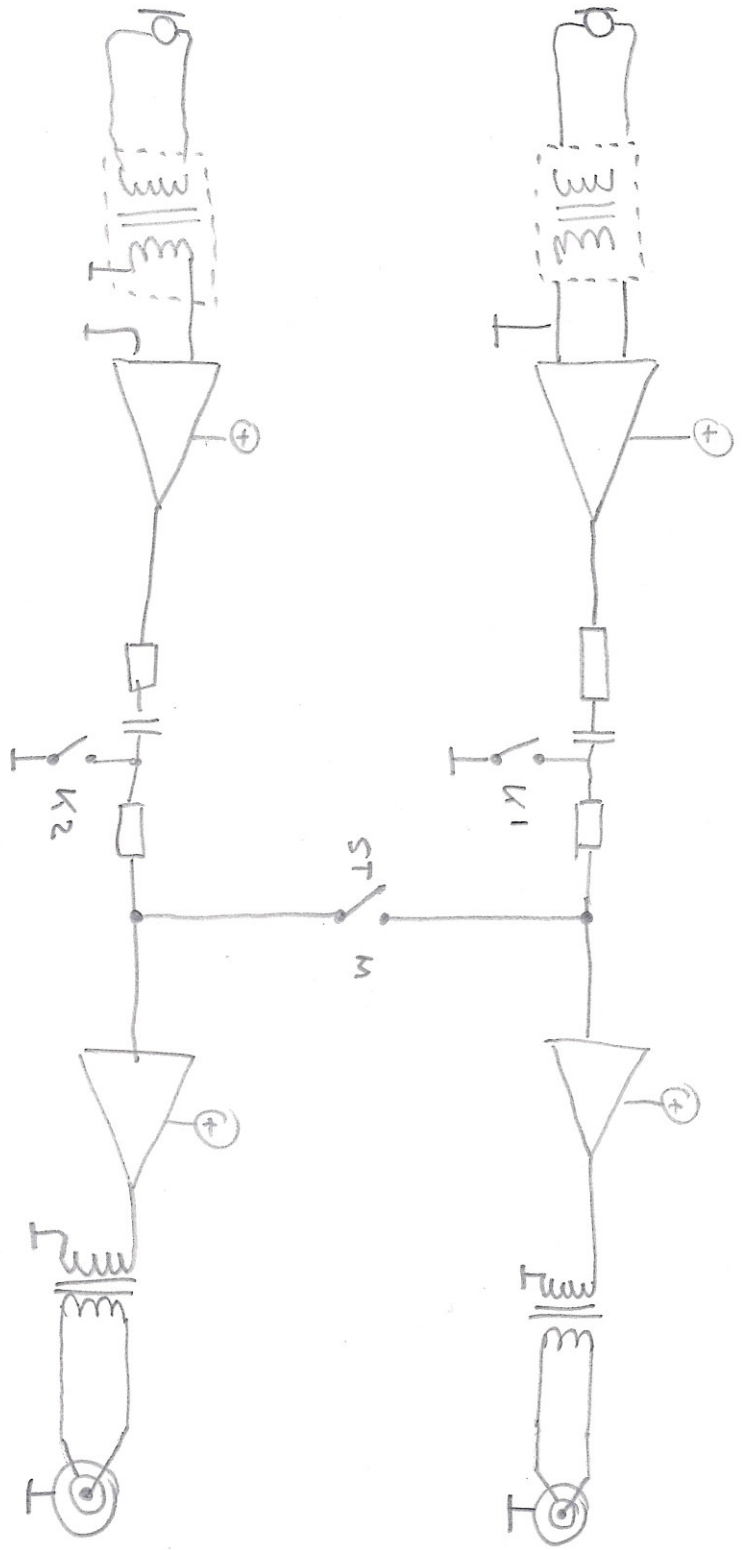
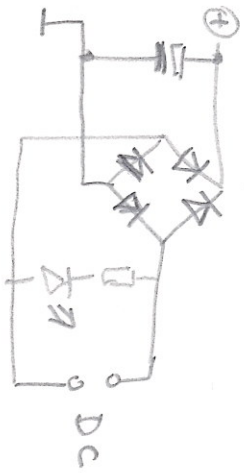

PRINCIPESCHEMA

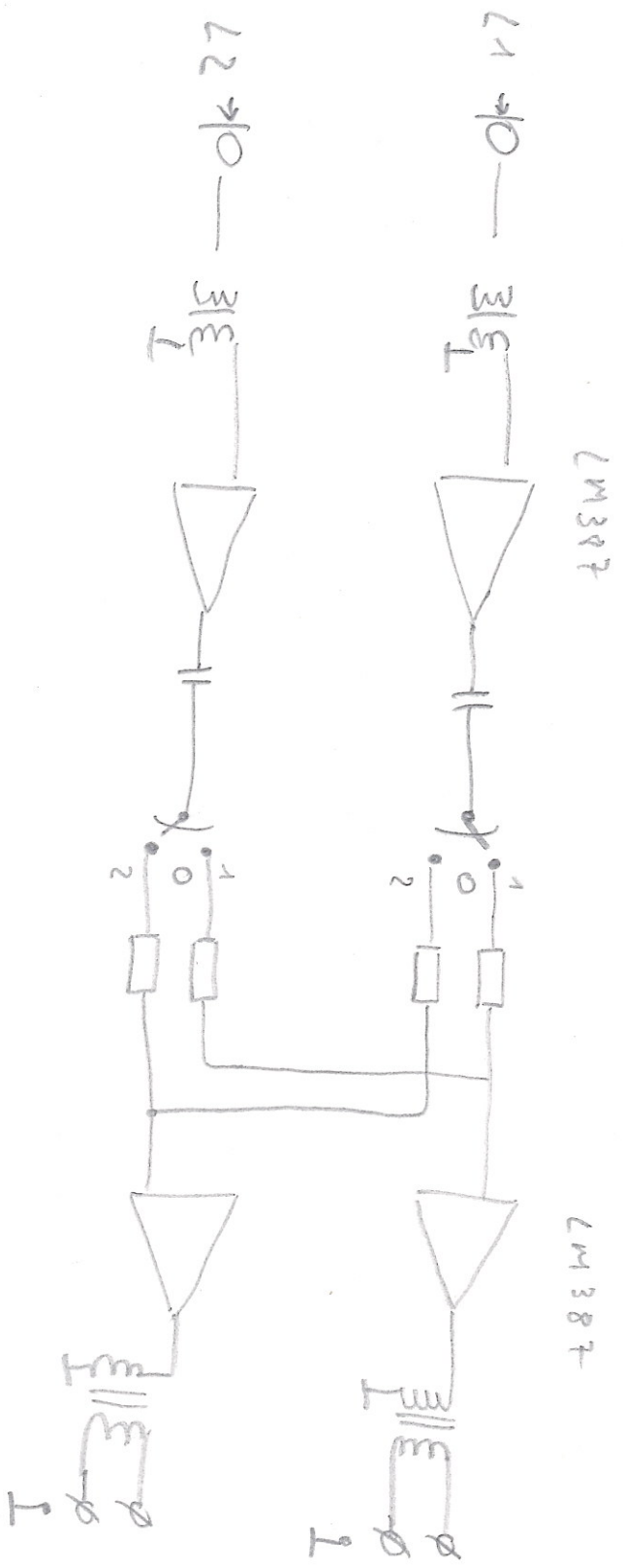

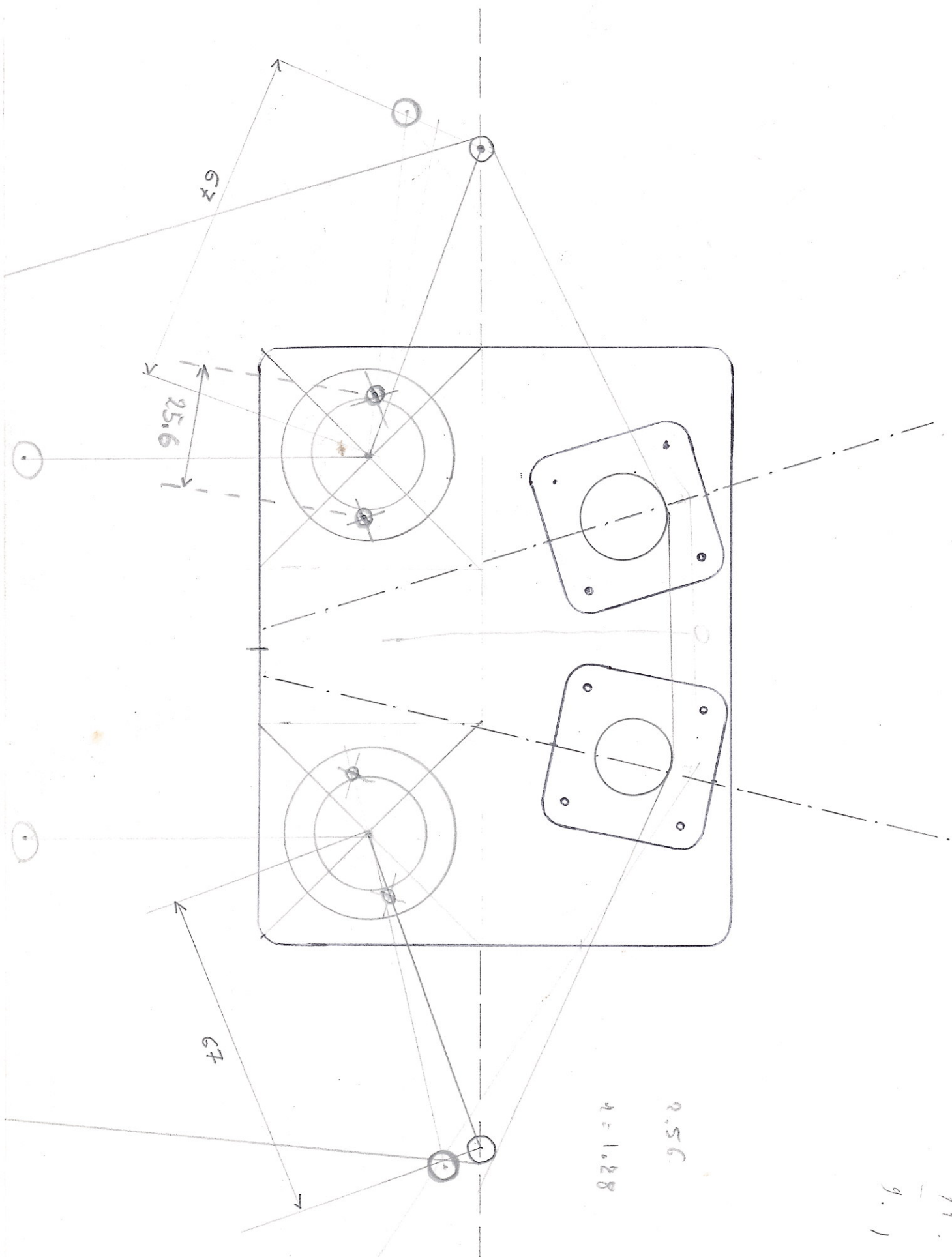

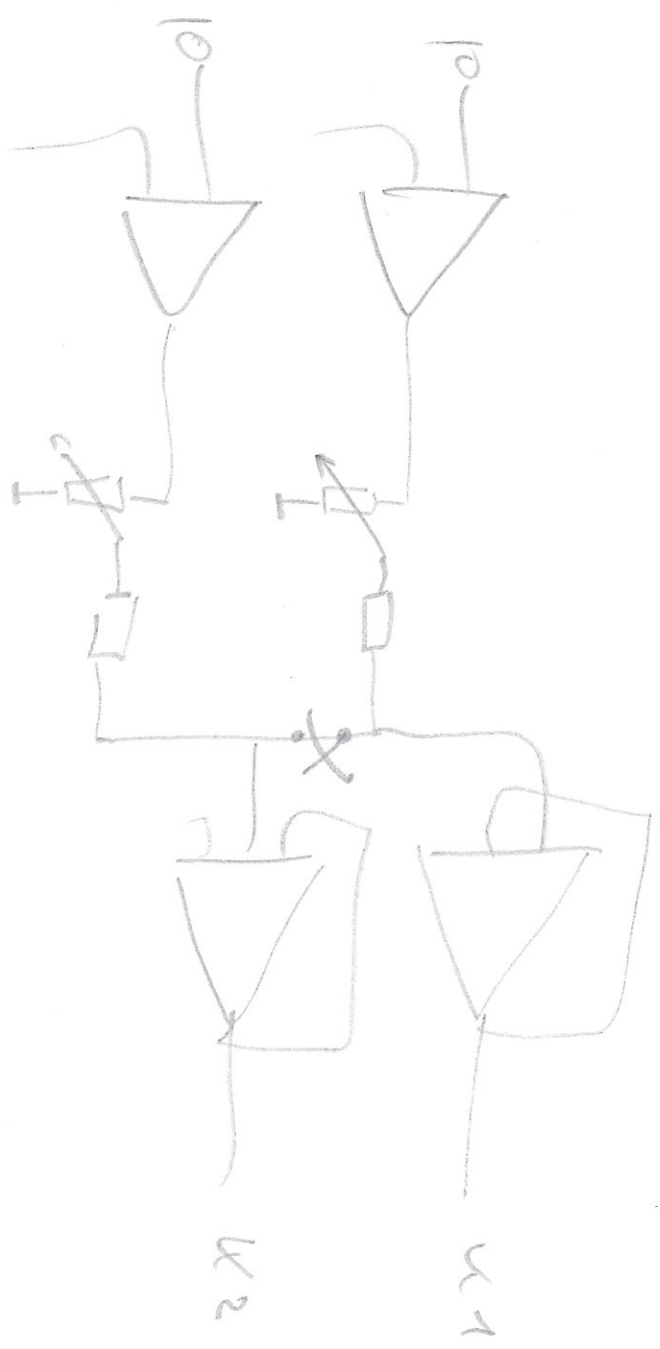
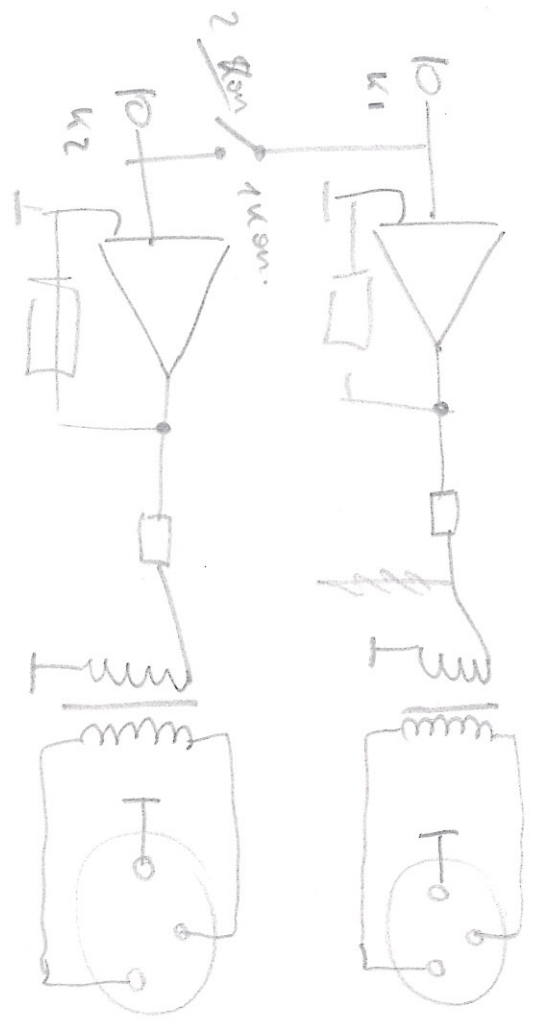



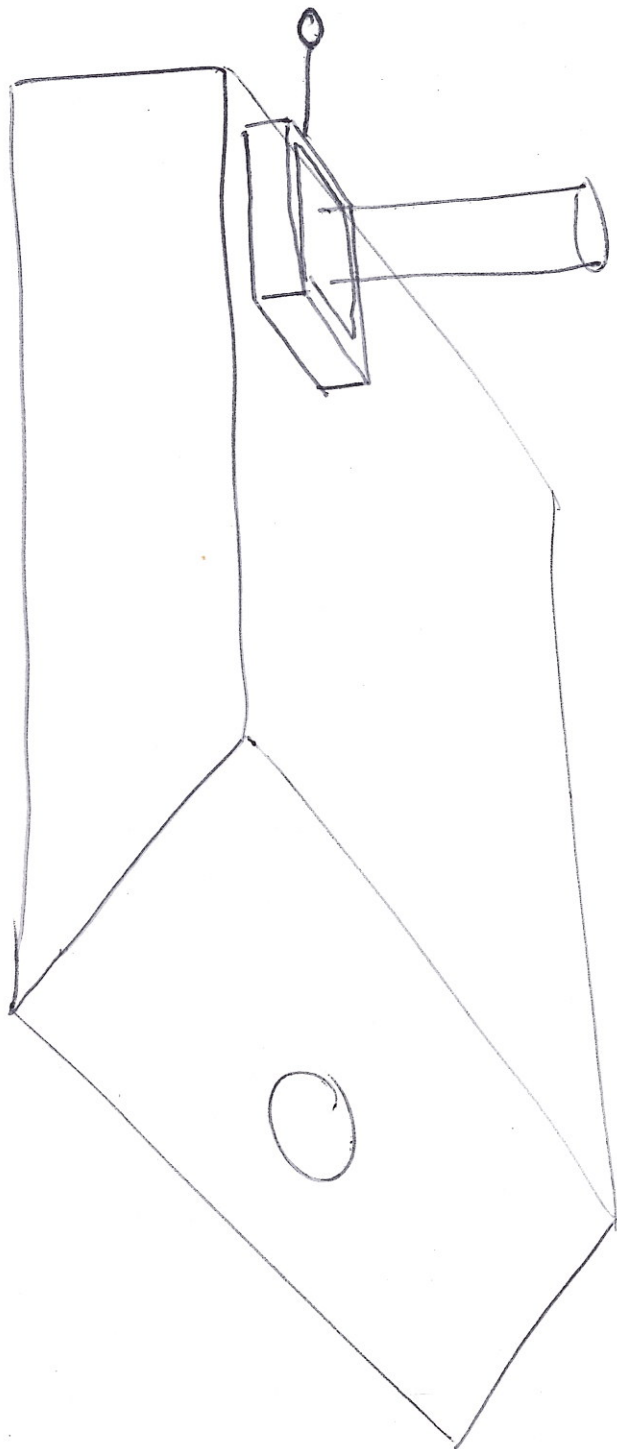

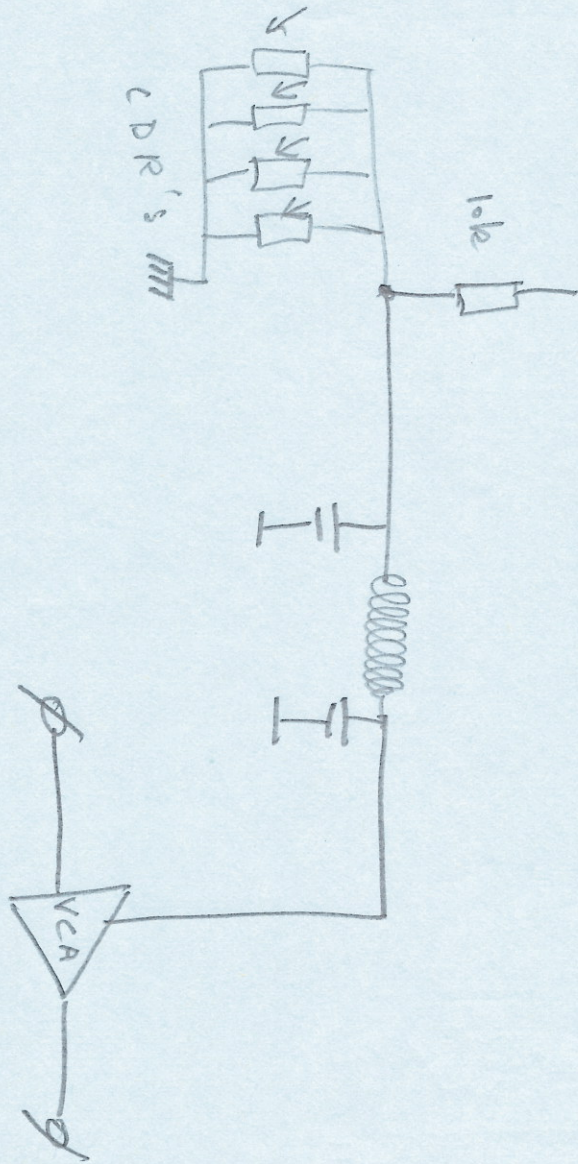
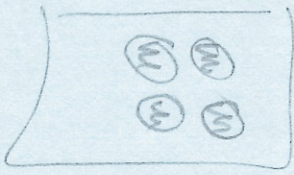

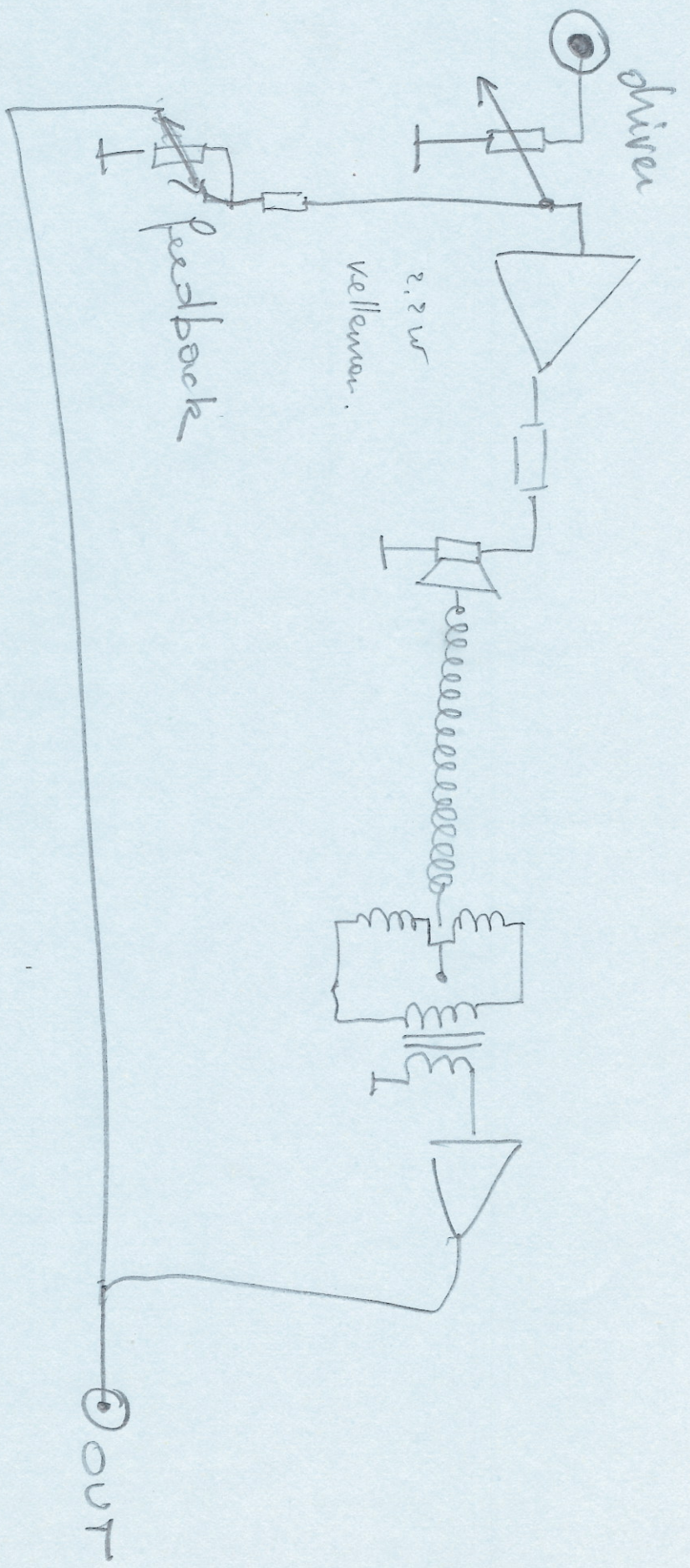

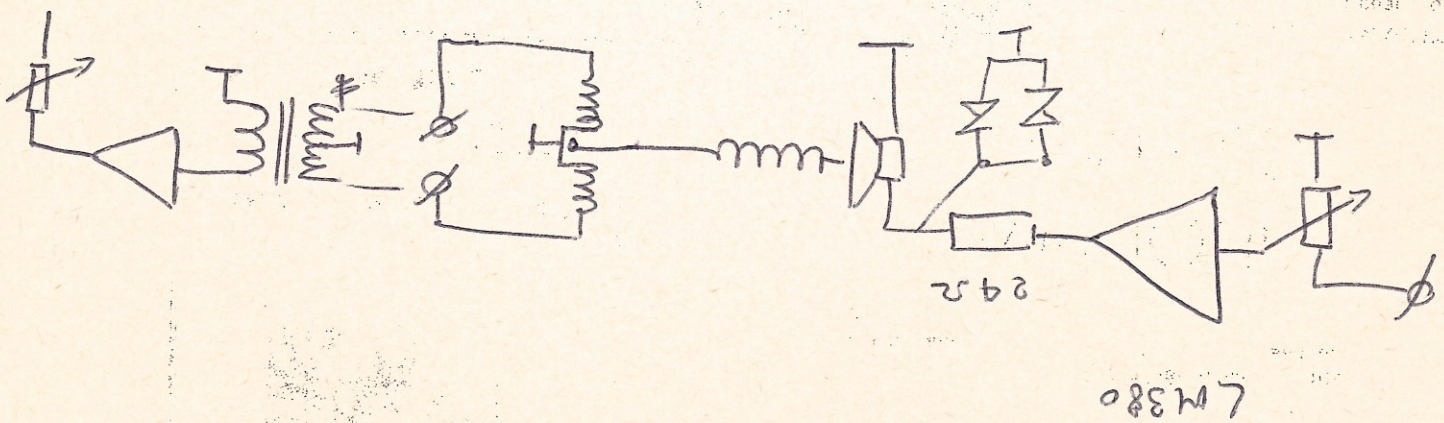
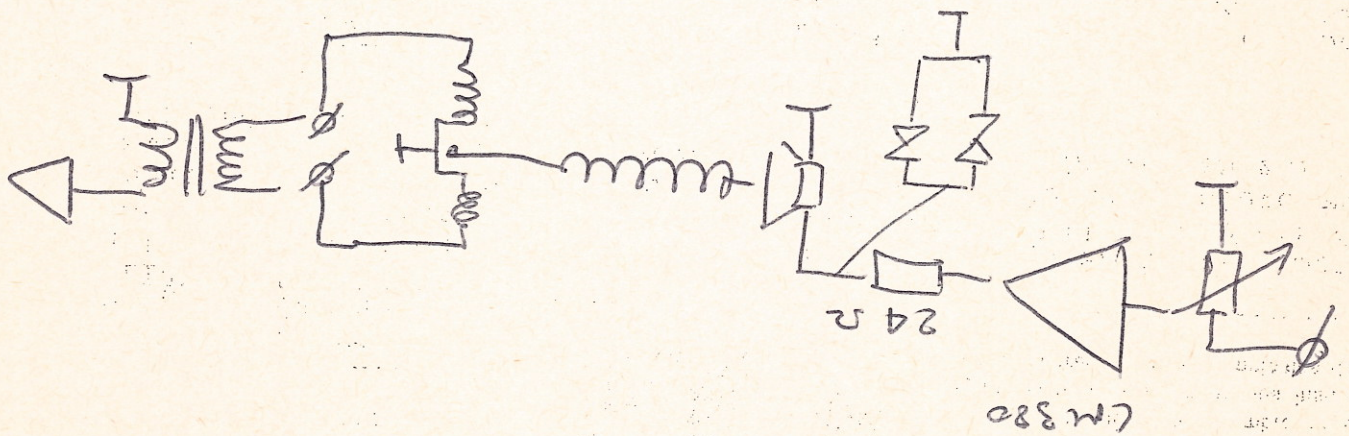

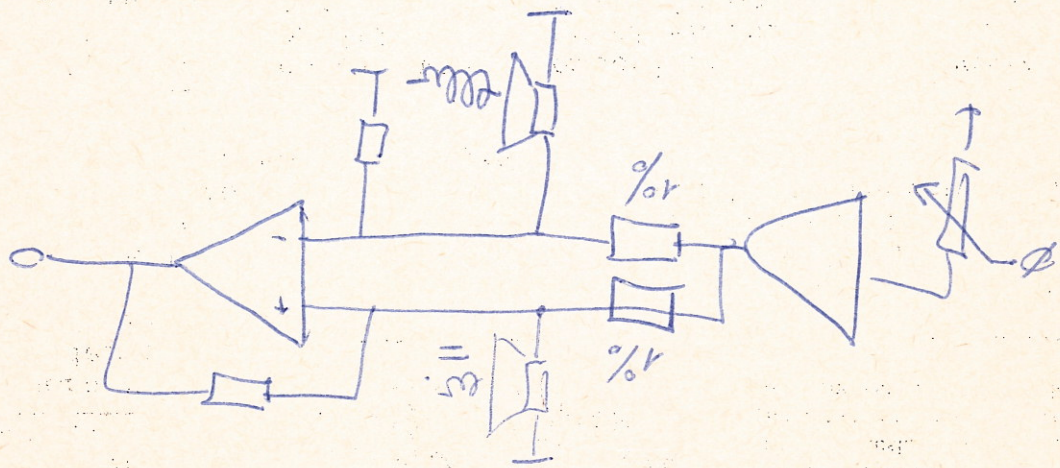
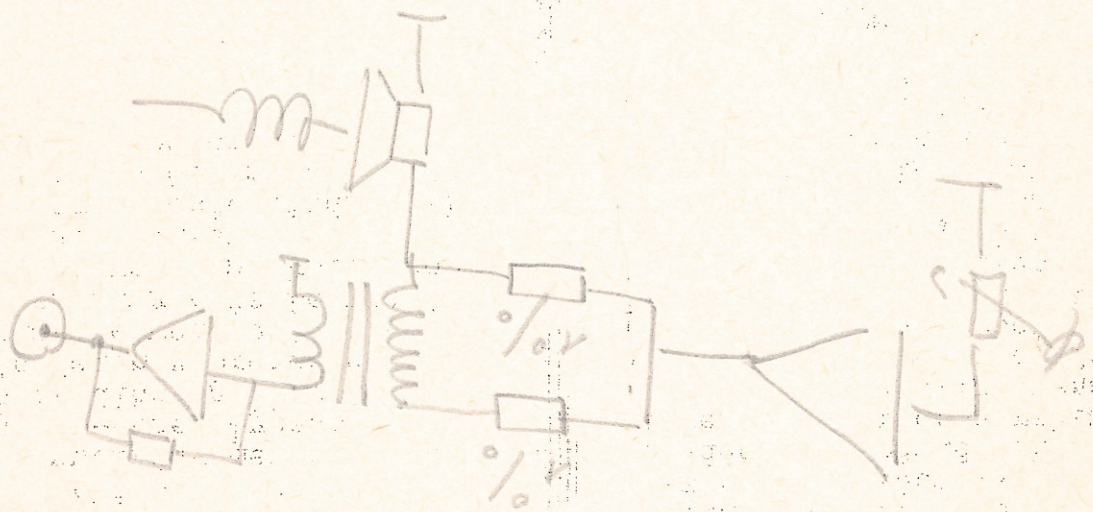

Like 11: Common emitter/receiver

Like 11

FOUR

FOUR

FOUR

4V

16

$2 \times 8V^2$

$\overline{0.8V}$

$V = \sqrt{0.8} = 0.89V$

$0.8V^2$

$\frac{I}{V} = 8$

0.1 A V.A.

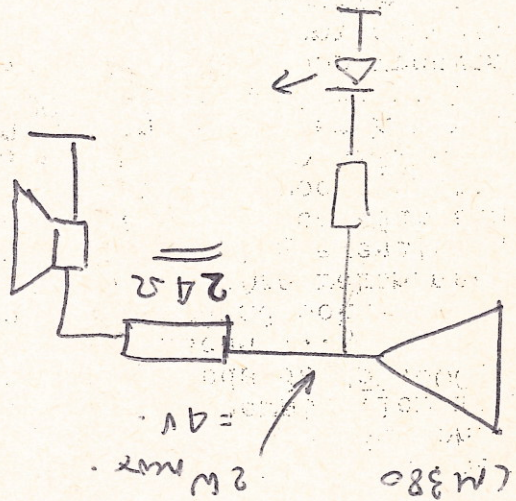

$\frac{8}{V} \times 0.1VA$

U

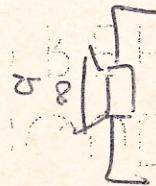

0.1 A V.A. by 8Ω L.S.