

Hex P2B

1 Nibble-card.

06/89

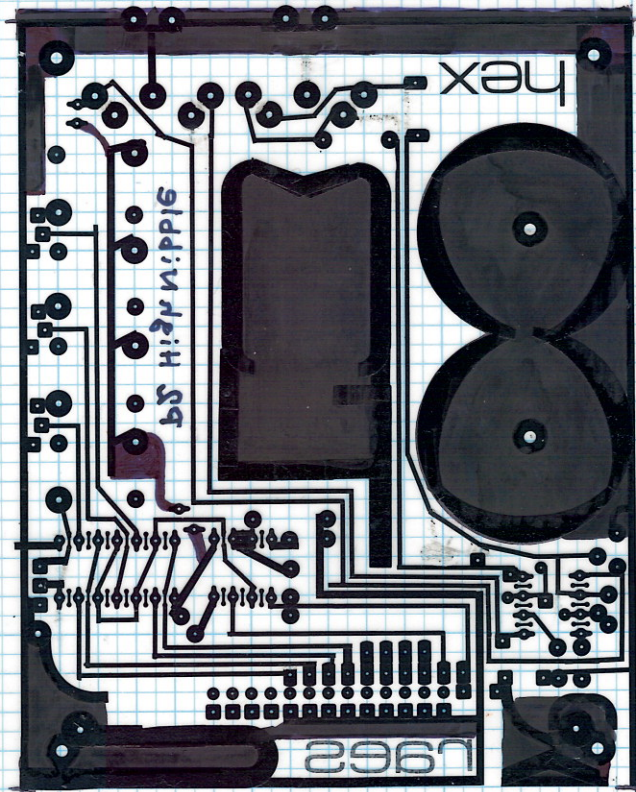

HEX PA/2

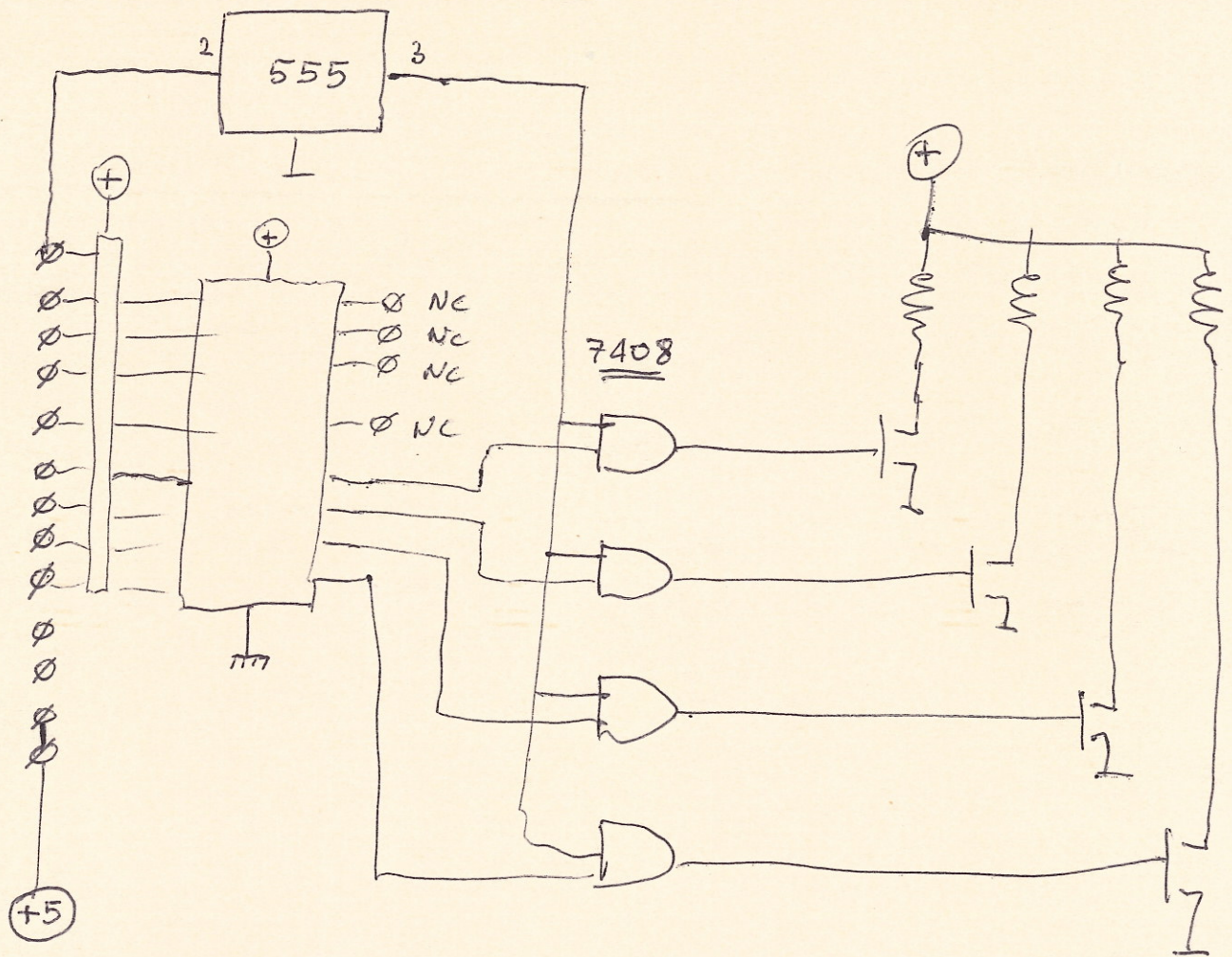

Voeding via flatcable pin 12 & 13

# Revisie P2 A a B-

? Voeding via flatcable

✓ Buskant

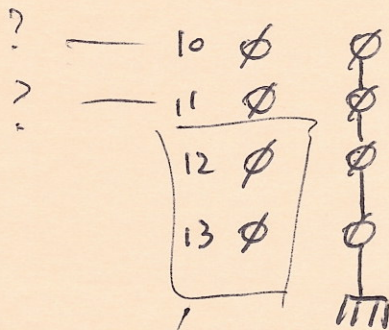
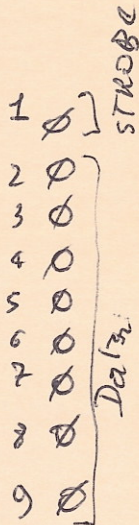

we as  
5V  
power line!

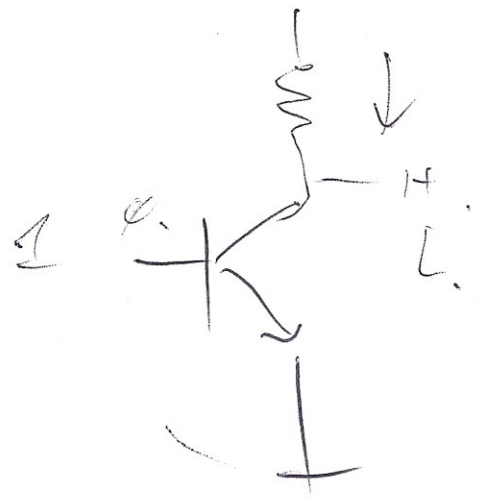
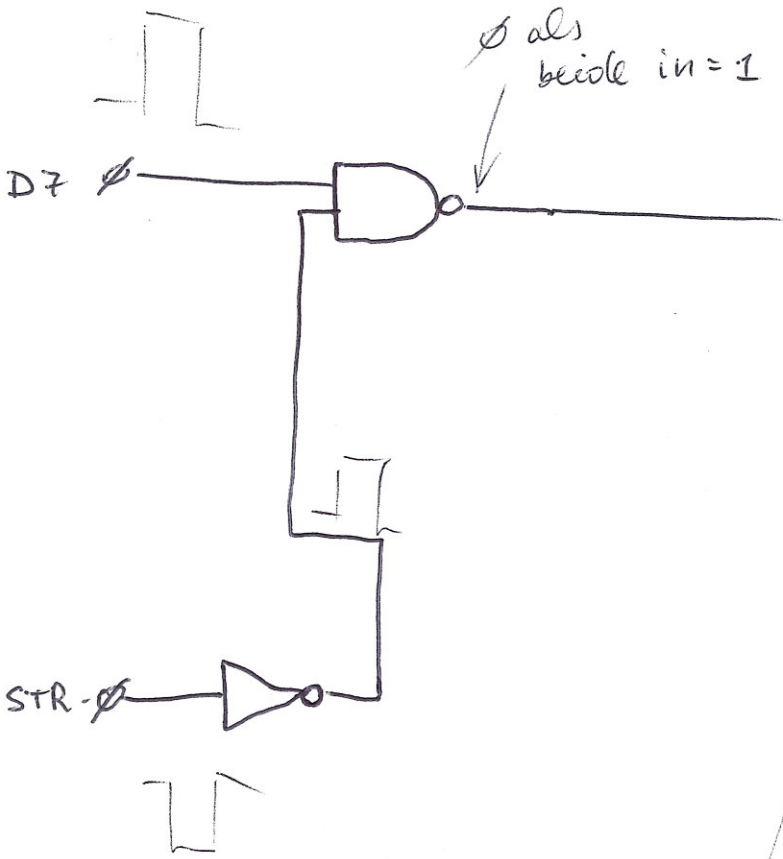

Moet AND  
worden!

$\phi$  alleen als beide 1 zijn.

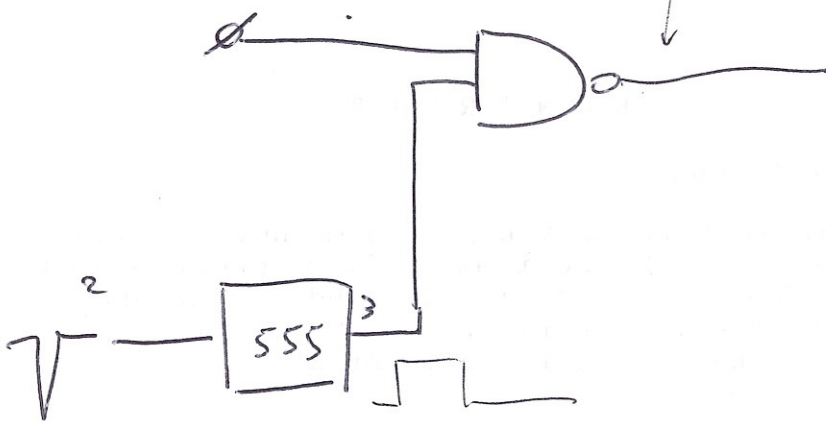

# Logos Editions

Logos foundation music publishing  
Kongostraat 35  
9000 GENT  
Belgium  
tel.:091/23.80.89

Title : " 2B v - 2B "

( Tubi or nor tubi )

Author:Godfried-Willem RAES

Wettelijk Depot : D-1989/2421/3

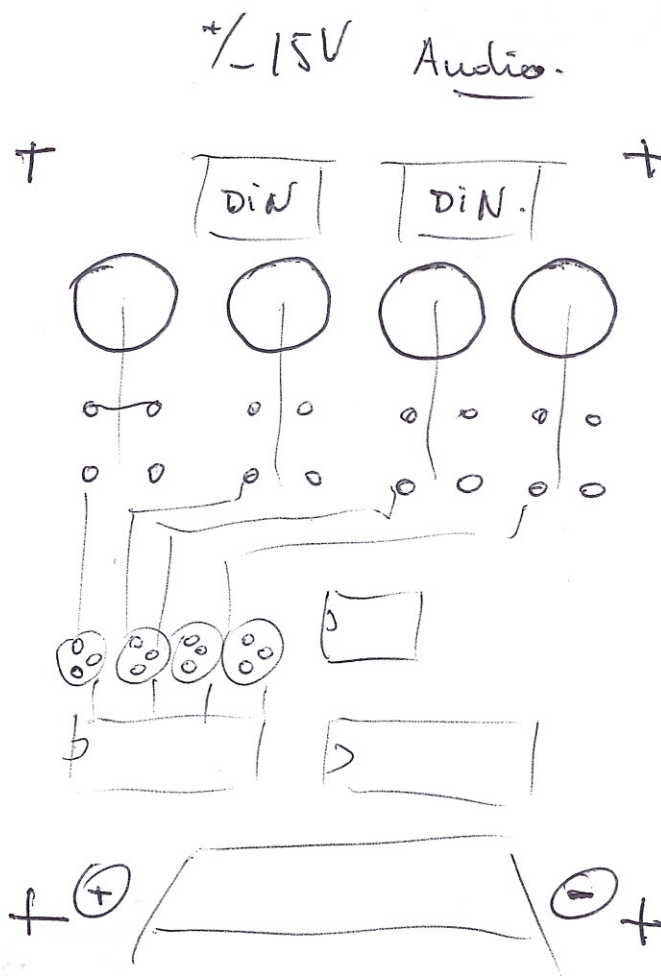

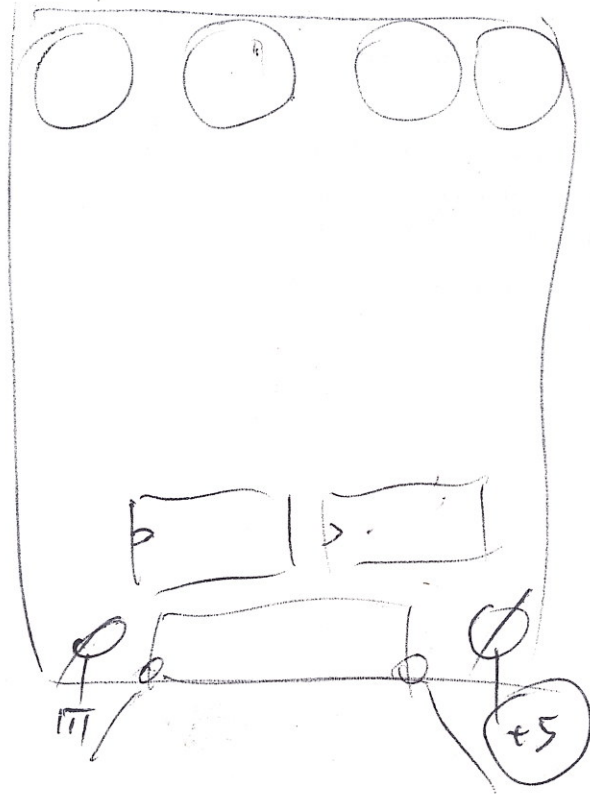
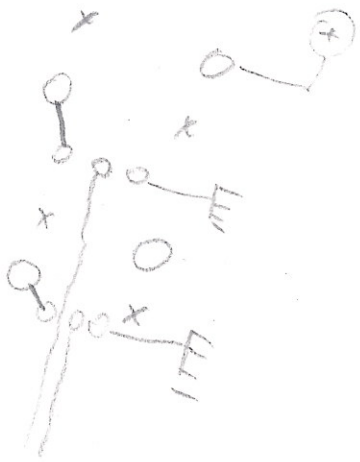
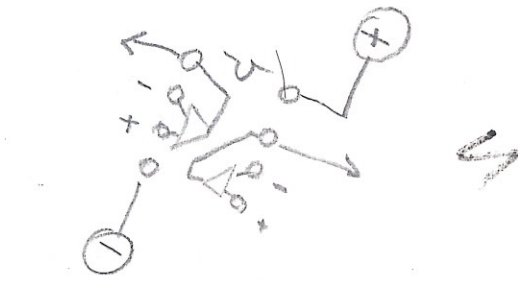
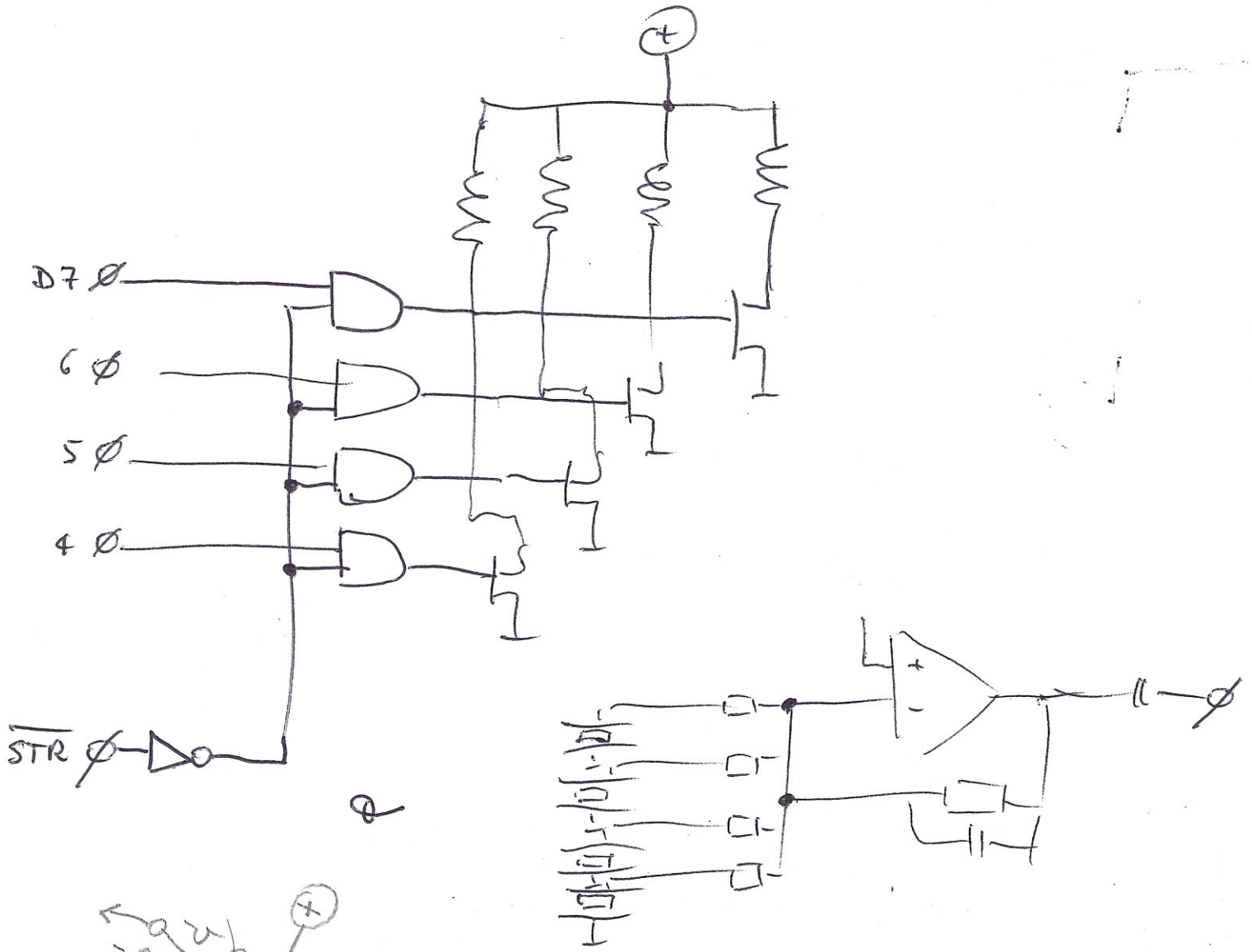

18.400.

