

Bel - tele foon

BEL - TELEFOON

A : even S2

$1/4 + 1/100!$

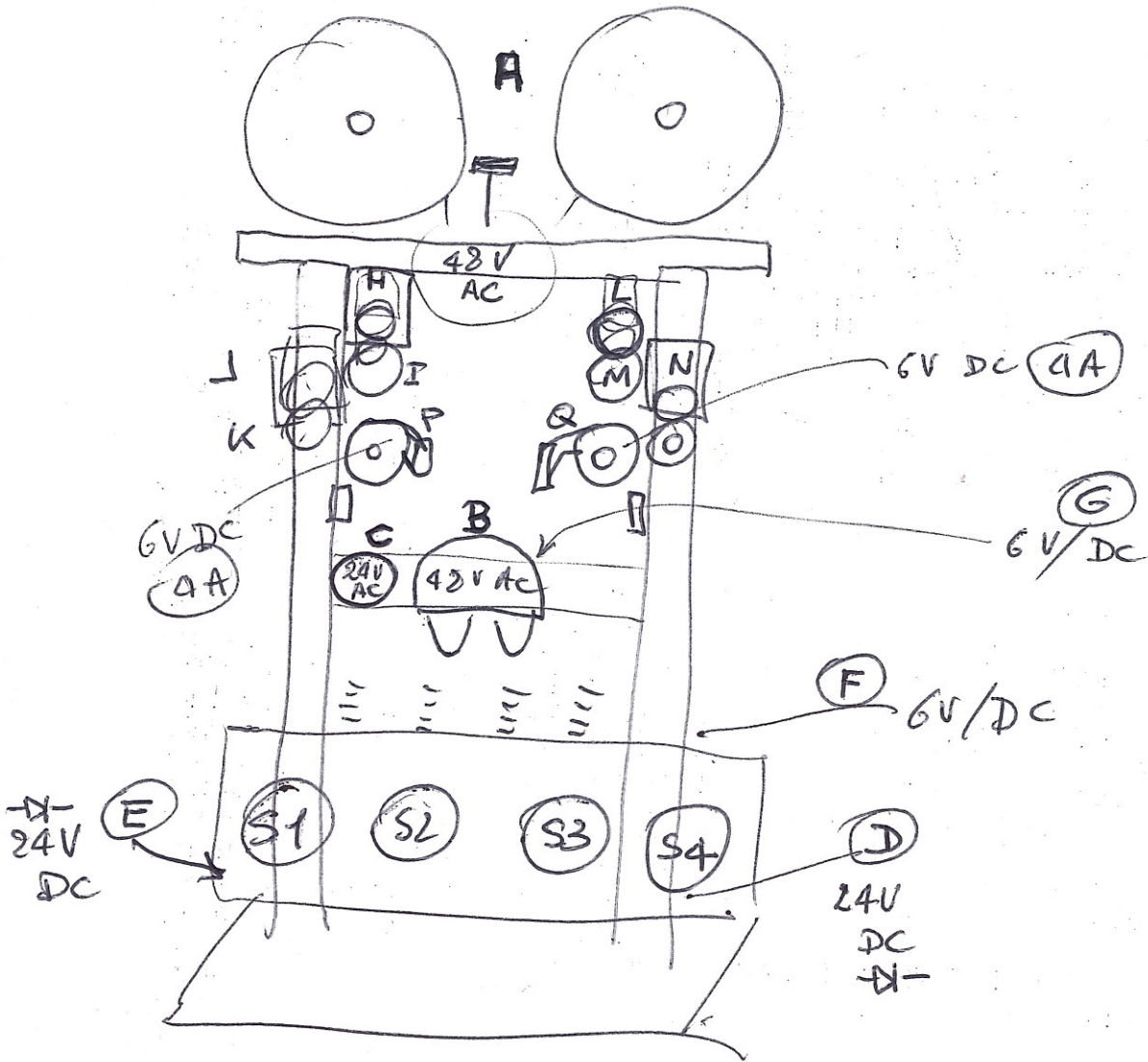

- A $1/4 + 1/100$
- B $1/100$
- C $1/100$
- D $1/100$
- E $1/100$
- F $1/100$
- G $1/100 + 1/100$

- H: S1 $1/100 + S2 1/100$
- I: $1/100 + 1/100$
- J $1/100 + 1/100$
- K $1/100 + 1/100$
- L $1/100 + 1/100$
- M $1/100 + 1/100$
- N $1/100 + 1/100$
- O $1/100 + 1/100$
- P $1:100?$
- Q $1:100?$

1 aktie : * kurze kiesschiff 1:4

* kurze nummer 1:10



select: 1 positie uit 11

"Bel - telefoon"

N^o 0

Schakeltoestand :

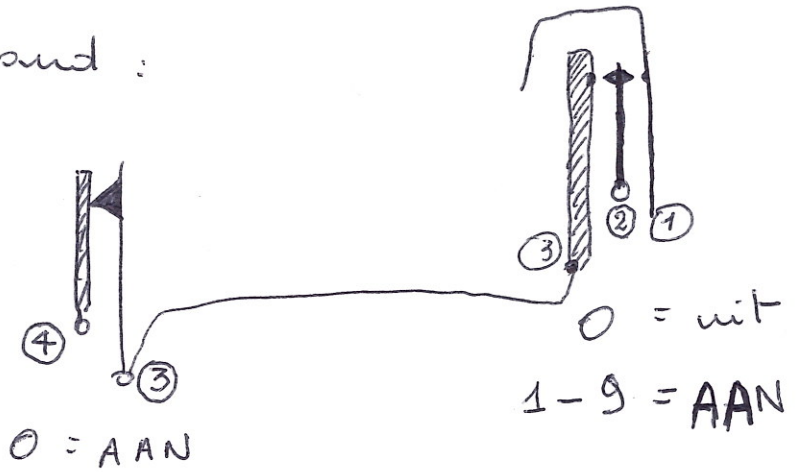

1-9 = pulsen
uit.

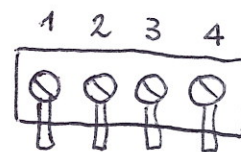
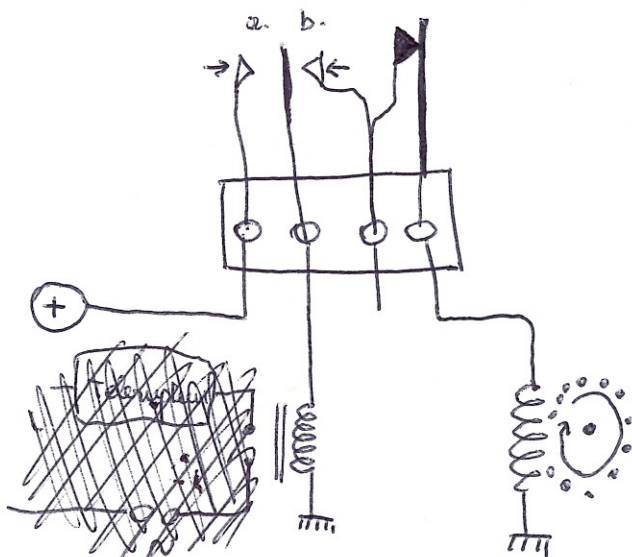
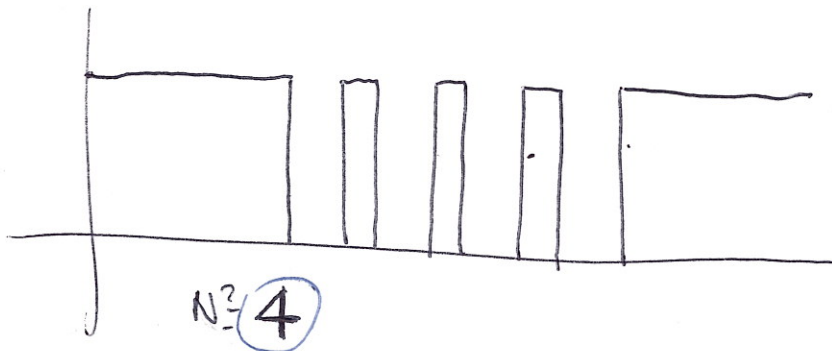

~~Over akoestische miljeuverschillen~~ Over akoestische miljeuverschillen.

Kawaai is ongeveest geluid.

Geluid is trilling van luchtmoleculen waargenomen door ons oor.

* gelu — stank

{ contacting. — pijn
gevoel.
voelen.

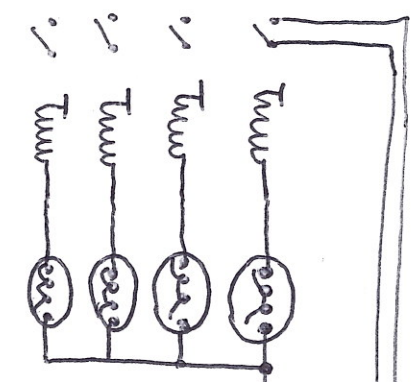
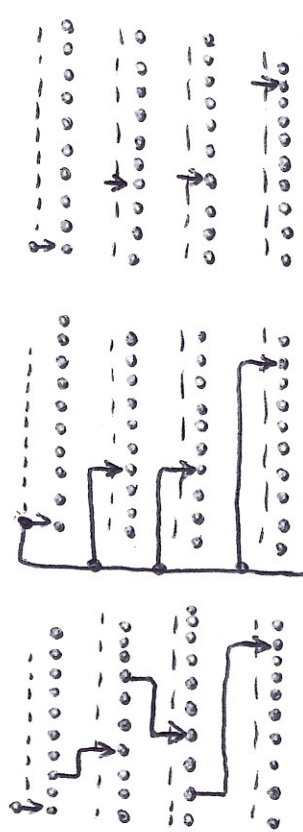
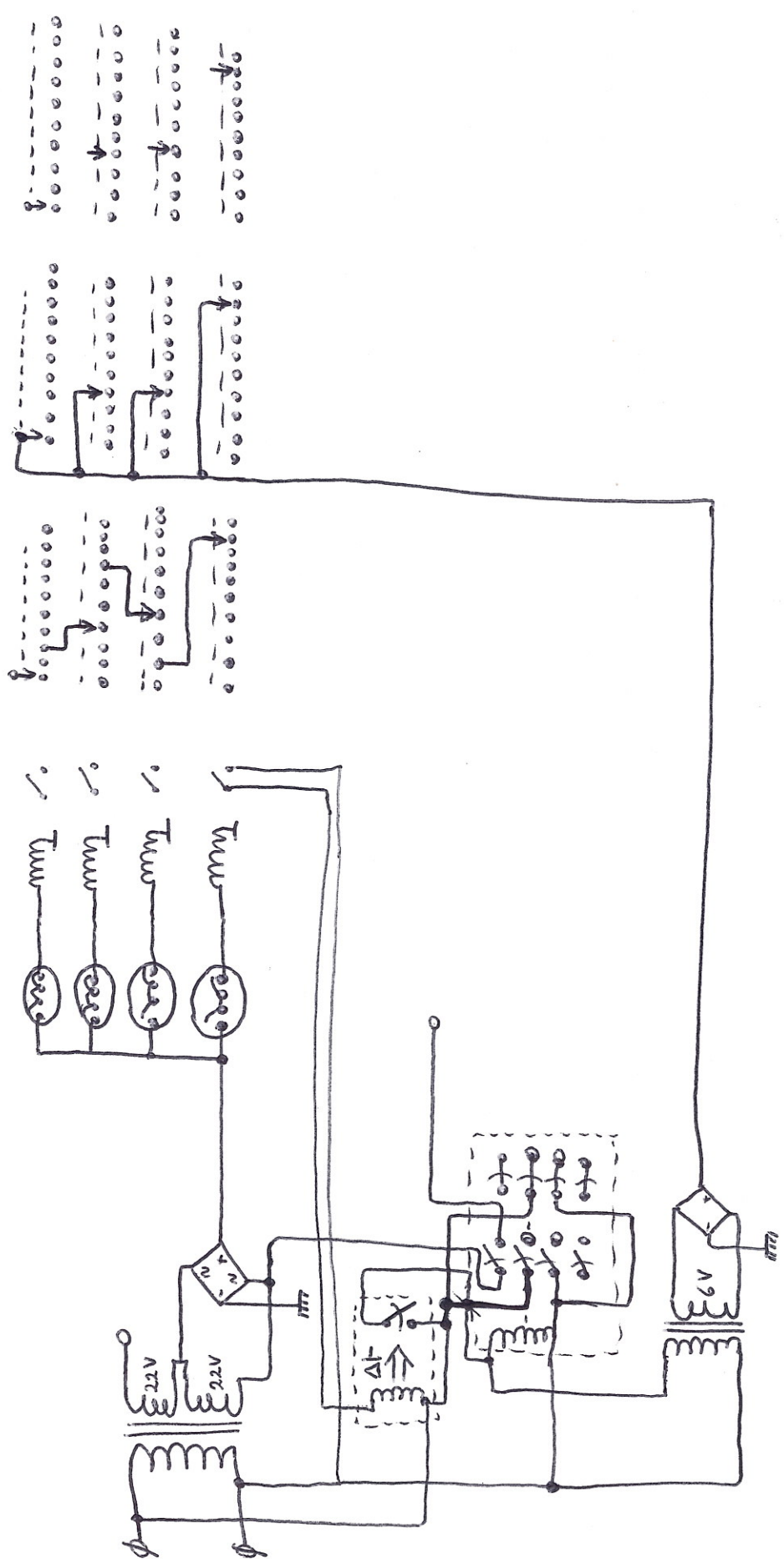

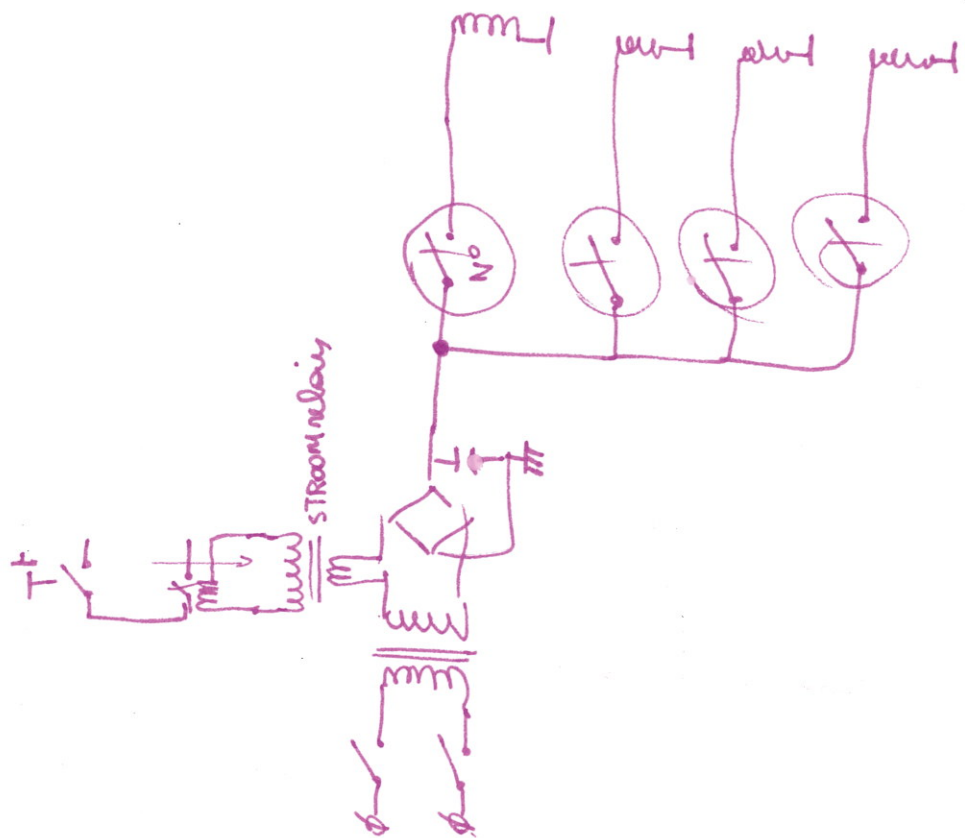

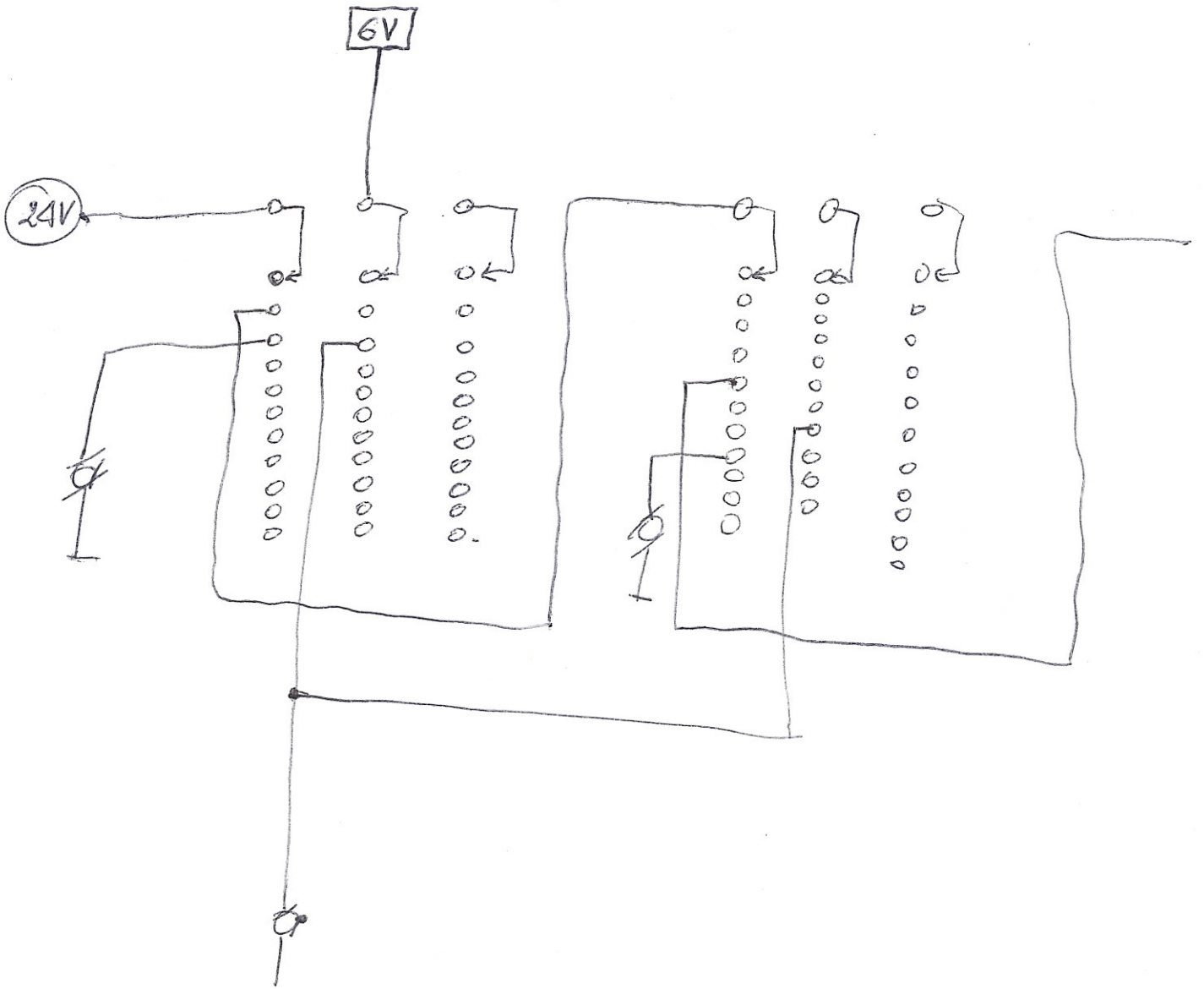

$$A = \bar{U}_{R_L} \sqrt{27}$$

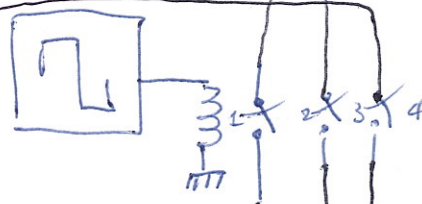
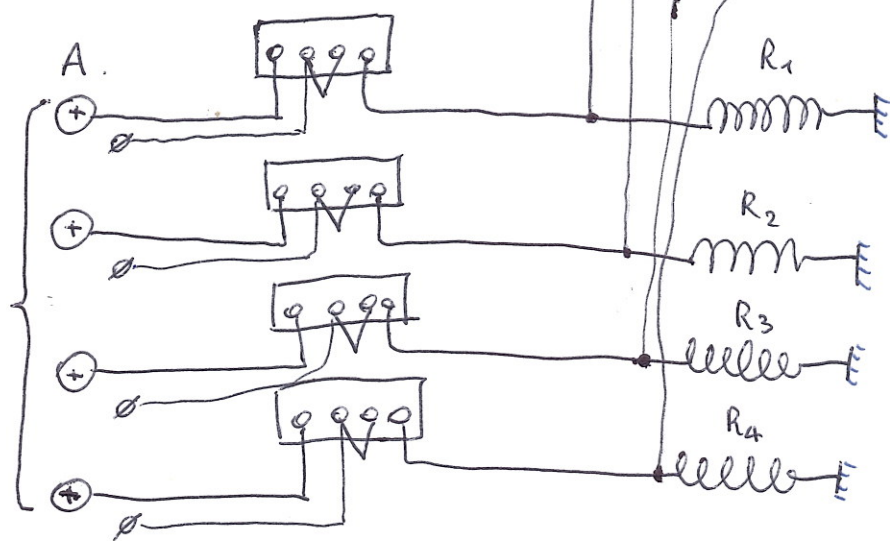

hoffelbel.
0000

